

Safety precautions to be strictly observed are marked with following symbols in the Operating Instructions:



The instruments must only be disposed of in the correct way!

Operating Instructions

Programmable Temperature Transmitter SINEAX V 608



Camille Bauer LTD
Aargauerstrasse 7
CH-5610 Wohlen/Switzerland
Phone +41 56 618 21 11
Fax +41 56 618 35 35
info@camillebauer.com
www.camillebauer.com



V 608-8 Be 142 117-02 03.11

Contents

1. Read first and then ...	1
2. Scope of supply	1
3. Brief description	1
4. Technical data	1
5. Mounting	2
6. Electrical connections	2
7. Configuring the transmitter	3
8. Commissioning	4
9. Maintenance	4
10. Accessories and spare parts	4
11. Releasing the transmitter	4
12. Dimensional drawings	4
13. Declaration of conformity	4

1. Read first and then ...



The proper and safe operation of the device assumes that the Operating Instructions are **read** and the safety warnings given in the various Sections

- 5. Mounting**
- 6. Electrical connections**
- 7. Configuring the transmitter**
- 8. Commissioning**

are **observed**.

The device should only be handled by appropriately trained personnel who are familiar with it and authorised to work in electrical installations. Unauthorized repair or alteration of the unit invalidates the warranty.

2. Scope of supply (Figs. 1 and 2)

Transmitter (1)

Order Code: Significance of the 2nd. and 3rd. digits

Description	Order Code
2. Version	608 - 8
Standard, not electrically isolated	1
EEx ia IIC T6, not electrically isolated	3
3. Configuration	
Basic configuration, programmed	0
Configured to order	1

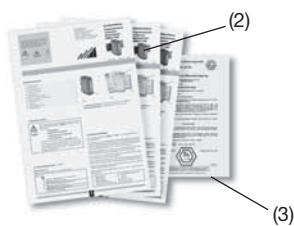

Fig. 1

Fig. 2

1 Operating Instructions (2) in German, French and English

1 Type Examination Certificate (3), only for "intrinsically safe" explosion-proof devices)

3. Brief description

The programmable **SINEAX V 608** is a two-wire transmitter.

It is used for measuring temperature in conjunction with a thermocouple or resistance thermometer. Thermocouple non-linearities are automatically compensated. The output signal is a current in the range 4...20 mA.

Measured variable, measuring range, signalling and other parameters are programmed with the aid of a PC and the corresponding software.

The sensor circuit is monitored for open and short-circuits and the output responds in a defined manner if one is detected.

The power supply of 12...30 V DC is connected together with the signal by the two leads connected to the measurement output (loop powered).

Explosion-proof "intrinsically safe" EEx ia IIC T6 versions rounds off the series of transmitters.

Transmitters supplied as standard versions are configured as follows:

– Measuring input:	Pt 100 for three-wire connection
– Measuring range:	0 ... 600 °C
– Measuring output:	4 ... 20 mA
– Open-circuit supervision:	Output 21.6 mA
– Mains ripple suppression:	For frequency 50 Hz

4. Technical data

Measuring input \rightarrow

Input variable and measuring range configured

Input variables	Measuring ranges		
	Limits	Min. span	Max. span
Temperatures with resistance thermometers for two, three or four-wire connection			
Pt 100, IEC 60 751	– 200 to 850 °C	50 K	850 K
Ni 100, DIN 43 760	– 60 to 250 °C	50 K	250 K
Temperatures with thermocouples			
Type B, E, J, K, N, R, S, T acc. to IEC 60 584-1	acc. to type	2 mV	80 mV
Type L and U, DIN 43 710			
Type W5 Re/W26 Re, Type W3 Re/W25 Re acc. to ASTM E 988-90			

Cold junction compensation

Internal:	Incorporated Pt 100 or with Pt 100 connected to the terminals
External:	Via cold junction thermostat 0 ... 60 °C, configurable

Measuring output

Output signal IA:

(output/powering circuit)
Impressed DC current,
linear with temperature

Standard range:

4 ... 20 mA, 2-wire technique

External resistance (load):

$$R_{\text{ext max.}} = \frac{\text{Power supply [V]} - 12 \text{ V}}{\text{Max. output current [mA]}}$$

Load max. [Ω] with 20 mA output

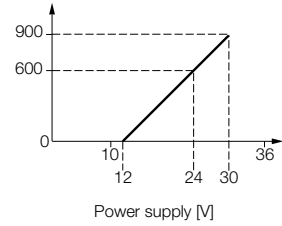

Programming connector on the transmitter

Interface: Serial interface

Open and short-circuit sensor circuit supervision

Signalling modes:

Output signal configurable to ...
... the value the output had immediately prior to the open or short-circuit* (hold value)
... a value between 4 and 21.6 mA

* The short-circuit indicator is only active for the RTD $\geq 100 \Omega$ at 0 °C, three and four-wire measuring mode

Power supply

DC voltage:

Supply 12 ... 30 V DC
max. residual ripple 1% p.p.
(supply must not fall below 12 V)
Protected against wrong polarity

5. Mounting

The SINEAX V 608 can be mounted on a top-hat rail or on a rail "G".



When deciding where to install the transmitter (measuring location), take care that the **limits** of the operating temperature **are kept**:

Standard instruments: - 25 and + 80 °C
Ex version: - 25 to max. 55 °C
(depending on P, see type examination certificate)!

Simply clip the device onto the top-hat rail (EN 50 022) (see Fig. 3).

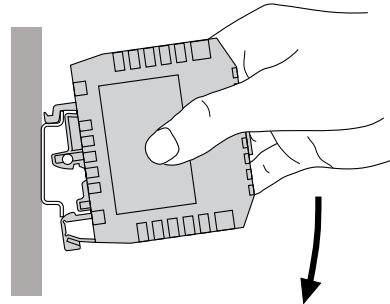

Fig. 3. Mounting onto top-hat rails 35 × 15 or 35 × 7.5 mm.

Simply clip the device onto the rail "G" EN 50 035-G32 (see Fig. 4).

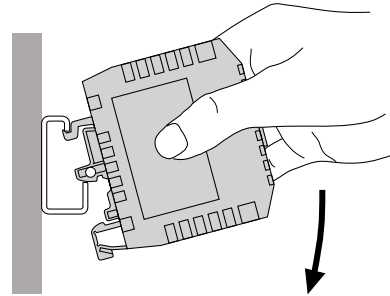



Fig. 4. Mounting onto rail "G".

6. Electrical connections

The leads are connected to the screw terminals for max. 0 to 4mm² (single wire) and 0 to 2.5 mm² (fine wire) on the front of the transmitter. The applicable enclosure Protection Class for the terminals is IP 20 according to EN 60 529.



Also note that, ...

... the data required to carry out the prescribed measurement must correspond to those marked on the nameplate of SINEAX V 608 (, Range, , Supply Voltage) (see Fig. 6)!

... the total loop resistance connected to the output (receiver plus leads) **does not** exceed the maximum permissible value R_{ext} , see "**Measuring output**" in Section "4. Technical data"!

... the measurement input and output cables should be twisted pairs and run as far as possible away from heavy current cables!

In all other respects, observe all local regulations when selecting the type of electrical cable and installing them!



In the case of "**Intrinsically safe**" explosion-proof, the supplementary information given on the type examination certification, the EN 60 079-14, and also local regulations applicable to electrical installation in explosion hazard areas must be taken into account!



6.1 Alternative measurement connections

Connect the measuring leads to suit the application as given in Table 1.

Table 1: Measuring input

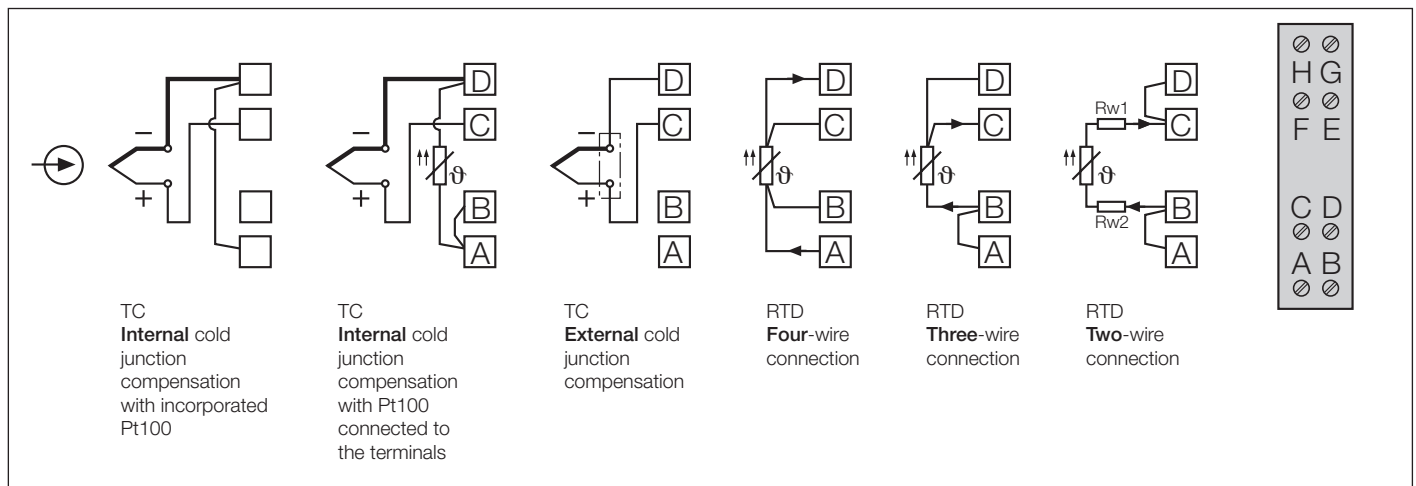

Notes:

6.1.1 Connection to thermocouples

Pay attention to correct polarity when connecting thermocouples. If the lead from the thermocouple to the transmitter has to be extended, be sure to use thermally compensated leads suitable for the particular type of thermocouple.

6.1.1.1 Internal cold junction compensation with incorporated Pt100

Connect terminals (A) and (D) when using internal compensation by comparison.

Set the configuration software to "internal thermo-element" and "Pt100 built-in".

6.1.1.2 Internal cold junction compensation with Pt 100 connected to the terminals

For this alternative, a Pt 100 is connected to terminals (A) and (D). Terminals (A) and (B) must be connected.

Set the configuration software "internal thermo-element" and "Pt100 on terminals".

6.1.1.3 External cold junction compensation

Be sure to configure the reference temperature when using a cold junction thermostat. The cold junction thermostat is connected to the transmitter by copper wire leads.

6.1.2 Connection to resistance thermometers

6.1.2.1 Two-wire connection

Terminals (A) and (B) and (C) and (D) must be connected in the case of a two-wire measurement.

The lead resistance must not be greater than 30 Ω per lead.

6.1.2.2 Three-wire connection

Terminals (A) and (B) must be connected in the case of a three-wire measurement. It is not necessary to compensate the leads, providing the three leads have identical resistances. The lead resistance must not be greater than 30 Ω per lead.

6.1.2.3 Four-wire connection

The four-wire measurement is independent of lead resistance within wide limits and therefore no compensation is necessary. The lead resistance must not be greater than 30 Ω per lead.

6.2 Measuring output leads (output/powering circuit)

Connect the measuring output leads (analogue output and power supply) to terminals (H) and (G) acc. to Fig. 5.

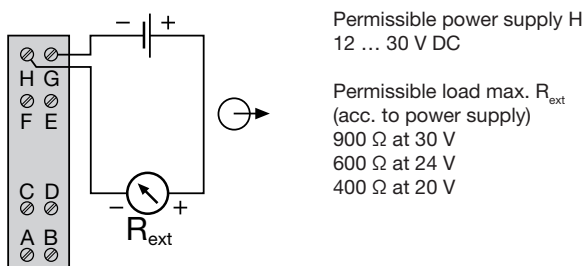

Fig. 5

Note that twisted leads must be used for the output signal.

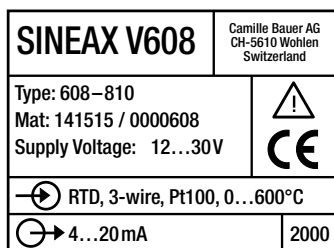

Fig. 6. Example of a nameplate.

7. Configuring the transmitter

It is configured via the serial interface of a PC. For the configuration, a special advantage is that devices of both the standard and Ex executions, with and without a separate power supply connection can be configured.

The following accessories are required:

- ... PC software V 600 plus (Order No. 146 557)
(Download free of charge under <http://www.camillebauer.com>)
- ... Programming cable PK 610 (Order No. 137 887)
- ... Ancillary cable (Order No. 141 416).

A PC with an RS 232 C interface (Windows 3.1x, 95, 98, NT ou 2000) is also required.

The configuration procedure and choice of parameters is explained by the menu-guided configuration program.

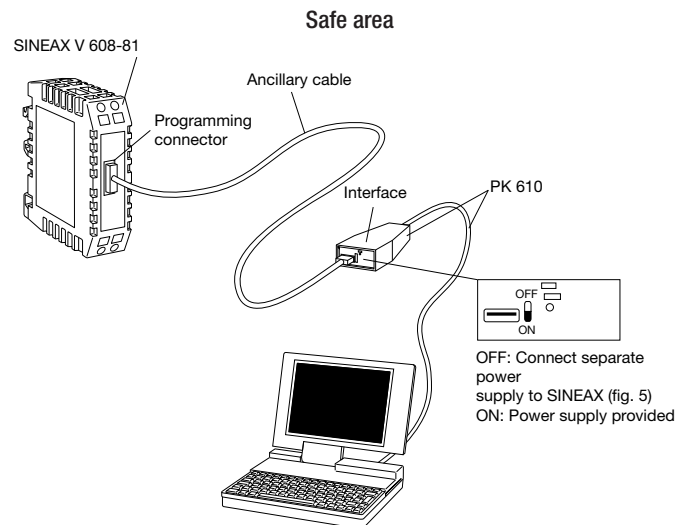

Fig. 7. Configuring a SINEAX V 608 without the power supply. For this case the switch on the interface must be set to "ON".

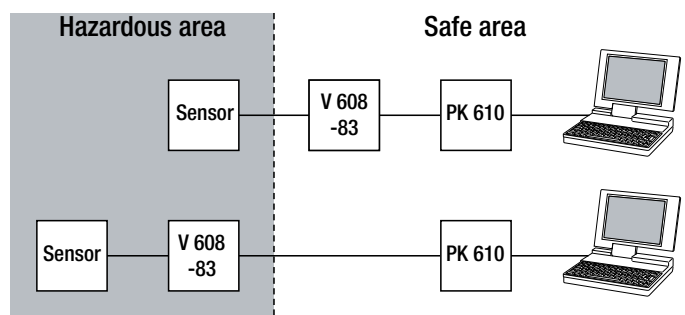



Fig. 8. Configuring the SINEAX V 608, type V 608-83 when the transducer and/or the sensor are in the hazardous area.

Depending on whether the device is programmed with or without a separate power supply, the switch on the PK 610 interface is to be set to "ON" or "OFF". See Fig. 7.



The earthing conditions must be observed when programming the instrument, (e.g. the instrument is installed in the plant).
If one of the power supply or input wires is earthed, a PC without an earth connection must be used when programming (e.g. a notebook running on the batteries).
Under no circumstances should a PC be used running from a power supply with an earth connection, as this will damage the transducer.



For devices of the explosion protection type "intrinsically safe", the PC or laptop must support a voltage level of 500 Veff between the RS 232 interface and earth (e.g. battery operation). In particular, check other peripheral devices that are connected.



If the above voltage level is not supported (e.g. operation from the mains power supply) the earth connection of the programming cable PK 610 must be connected to the potential equalization conductor. At the same time, it must be ensured that the programming circuit of the V 608 is potential free.

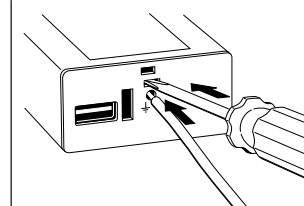

Fig. 9. Connect the earth connection to the PK 610 interface.

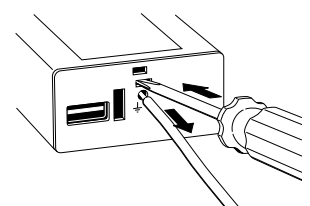

Fig. 10. Remove the earth connection from the PK 610 interface.

8. Commissioning



Switch on the measuring input and the power supply. The ambient temperature must be between -10 and $+80$ °C for standard instruments and -10 and max. 55 °C for Ex versions (depending on P_i, see type examination certificate).

9. Maintenance

No maintenance is required.

10. Accessories and spare parts

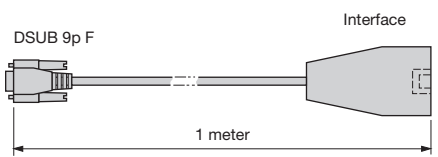
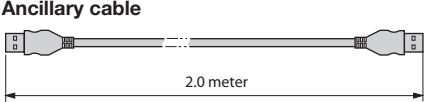
Description	Order No.
Programming cable PK 610 	137 887
Ancillary cable 	141 416
Configuration software V600 plus on CD (Download free of charge under http://www.camillebauer.com)	146 557
Operating Instructions V 608-8 Bd , in German	141 953
Operating Instructions V 608-8 Bf , in French	142 068
Operating Instructions V 608-8 Be , in English	142 117

11. Releasing the transmitter

Release the transmitter from a top-hat rail as shown in Fig. 11.

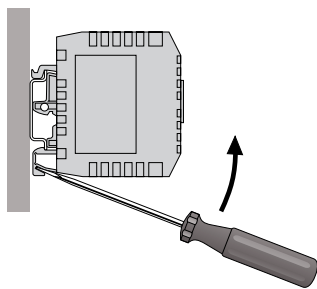

Fig. 11

Release the transmitter from a rail "G" as shown in Fig. 12.

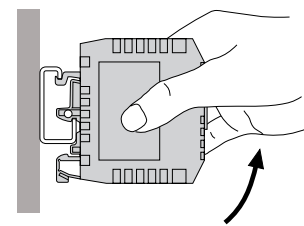

Fig. 12

12. Dimensional drawings

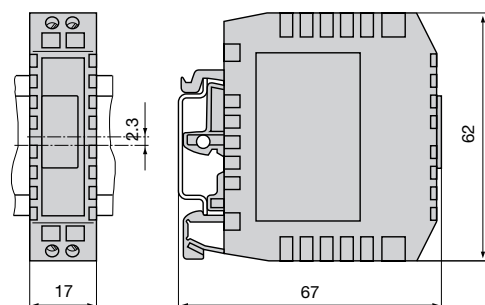

Fig. 13. SINEAX V 608 in housing **K17** clipped onto a top-hat rail EN 50 022 - 35×7.5 mm.

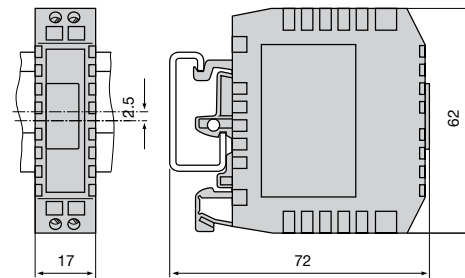

Fig. 14. SINEAX V 608 in housing **K17** clipped onto a rail "G" EN 50 035 - G32.

13. Declaration of conformity

CE		EG - KONFORMITÄTSERKLÄRUNG DECLARATION OF CONFORMITY	
Dokument-Nr./ Document No.:		V608_CE-konf.DOC	
Hersteller/ Manufacturer:		Camille Bauer AG Switzerland	
Anschrift / Address:		Aargauerstrasse 7 CH-5610 Wohlen	
Produktbezeichnung/ Product name:		Programmierbarer Temperatur-Messumformer Programmable temperature transmitter	
Typ / Type:		SINEAX V 608	
Das bezeichnete Produkt stimmt mit den Vorschriften folgender Europäischer Richtlinien überein, nachgewiesen durch die Einhaltung folgender Normen:			
The above mentioned product has been manufactured according to the regulations of the following European directives proven through compliance with the following standards:			
Nr. / No.	Richtlinie / Directive		
2004/108/EG	Elektromagnetische Verträglichkeit - EMV - Richtlinie		
2004/108/EC	Electromagnetic compatibility - EMC directive		
EMV / EMC	Fachgrundnorm / Generic Standard	Messverfahren / Measurement methods	
Störaussendung / Emission	EN 61000-6-4 : 2007	EN 55011 : 2007+A2:2007	
Störfestigkeit / Immunity	EN 61000-6-2 : 2005	IEC 61000-4-2: 1995+A1:1998+A2:2001 IEC 61000-4-3: 2006+A1:2007 IEC 61000-4-4: 2004 IEC 61000-4-5: 2005 IEC 61000-4-6: 2008	
Nr. / No.	Richtlinie / Directive		
2006/95/EG	Elektrische Betriebsmittel zur Verwendung innerhalb bestimmter Spannungsgrenzen - Niederspannungsrichtlinie - CE-Kennzeichnung : 95		
2006/95/EC	Electrical equipment for use within certain voltage limits - Low Voltage Directive - Attachment of CE mark : 95		
EN/Norm/Standard	IEC/Norm/Standard		
EN 61 010-1 : 2001	IEC 1010-1 : 2001		
Die explosionsgeschützte Ausführung dieses Produkts stimmt mit der Europäischen Richtlinie 94/9/EG überein. The explosion protected variant of this product has been manufactured according the European directive 94/9.			
Ort, Datum / Place, date:		Wohlen, 2. Oktober.2009	
Unterschrift / signature:			
M. Ulrich Leiter Technik / Head of engineering		J. Brem Qualitätsmanager / Quality manager	