

# DUSTTRAK™ DRX AEROSOL MONITOR MODEL 8533/8534/8533EP

OPERATION AND SERVICE MANUAL



DustTrak DRX 8533 Desktop and 8534 Handheld



DustTrak DRX 8533EP Monitor



# START SEEING THE BENEFITS OF REGISTERING TODAY!

---

Thank you for your TSI instrument purchase. Occasionally, TSI releases information on software updates, product enhancements and new products. By registering your instrument, TSI will be able to send this important information to you.

**<http://register.tsi.com>**

As part of the registration process, you will be asked for your comments on TSI products and services. TSI's customer feedback program gives customers like you a way to tell us how we are doing.



UNDERSTANDING, ACCELERATED

**TSI Incorporated** - Visit our website **[www.tsi.com](http://www.tsi.com)** for more information.

**USA**

**Tel:** +1 800 874 2811

**UK**

**Tel:** +44 149 4 459200

**France**

**Tel:** +33 491 11 87 64

**Germany**

**Tel:** +49 241 523030

**India**

**Tel:** +91 80 67877200

**China**

**Tel:** +86 10 8251 6588

**Singapore**

**Tel:** +65 6595 6388

©2012 TSI Incorporated

Printed in U.S.A.

**Copyright ©**

TSI Incorporated / 2008–2013 / All rights reserved.

**Address**

TSI Incorporated / 500 Cardigan Road / Shoreview, MN 55126 / USA

**Fax No.**

(651) 490-3824

**Limitation of Warranty and Liability (effective January 2012)**

(For country-specific terms and conditions outside of the USA, please visit [www.tsi.com](http://www.tsi.com).)

Seller warrants the goods sold hereunder, under normal use and service as described in the operator's manual, shall be free from defects in workmanship and material for twenty-four (24) months, or if less, the length of time specified in the operator's manual, from the date of shipment to the customer. This warranty period is inclusive of any statutory warranty. This limited warranty is subject to the following exclusions and exceptions:

- a. Hot-wire or hot-film sensors used with research anemometers, and certain other components when indicated in specifications, are warranted for 90 days from the date of shipment;
- b. DustTrak internal pump for Models 8530 and 8533 is warranted for two (2) years or 4000 hours, whichever comes first;
- c. DustTrak external pump for Models 8530EP and 8533EP is warranted for two (2) years or 8760 hours, whichever comes first;
- d. DustTrak internal pump for Models 8530 and 8533 is warranted for operation within ambient temperatures between 5–45°C. Warranty is void when the internal pump is operating outside of this temperature range;
- e. Parts repaired or replaced as a result of repair services are warranted to be free from defects in workmanship and material, under normal use, for 90 days from the date of shipment;
- f. Seller does not provide any warranty on finished goods manufactured by others or on any fuses, batteries or other consumable materials. Only the original manufacturer's warranty applies;
- g. Unless specifically authorized in a separate writing by Seller, Seller makes no warranty with respect to, and shall have no liability in connection with, goods which are incorporated into other products or equipment, or which are modified by any person other than Seller.

The foregoing is **IN LIEU OF** all other warranties and is subject to the **LIMITATIONS** stated herein. **NO OTHER EXPRESS OR IMPLIED WARRANTY OF FITNESS FOR PARTICULAR PURPOSE OR MERCHANTABILITY IS MADE. WITH RESPECT TO SELLER'S BREACH OF THE IMPLIED WARRANTY AGAINST INFRINGEMENT, SAID WARRANTY IS LIMITED TO CLAIMS OF DIRECT INFRINGEMENT AND EXCLUDES CLAIMS OF CONTRIBUTORY OR INDUCED INFRINGEMENTS. BUYER'S EXCLUSIVE REMEDY SHALL BE THE RETURN OF THE PURCHASE PRICE DISCOUNTED FOR REASONABLE WEAR AND TEAR OR AT SELLER'S OPTION REPLACEMENT OF THE GOODS WITH NON-INFRINGEMENTS.**

TO THE EXTENT PERMITTED BY LAW, THE EXCLUSIVE REMEDY OF THE USER OR BUYER, AND THE LIMIT OF SELLER'S LIABILITY FOR ANY AND ALL LOSSES, INJURIES, OR DAMAGES CONCERNING THE GOODS (INCLUDING CLAIMS BASED ON CONTRACT, NEGLIGENCE, TORT, STRICT LIABILITY OR OTHERWISE) SHALL BE THE RETURN OF GOODS TO SELLER AND THE REFUND OF THE PURCHASE PRICE, OR, AT THE OPTION OF SELLER, THE REPAIR OR REPLACEMENT OF THE GOODS. IN THE CASE OF SOFTWARE, SELLER WILL REPAIR OR REPLACE DEFECTIVE SOFTWARE OR IF UNABLE TO DO SO, WILL REFUND THE PURCHASE PRICE OF THE SOFTWARE. IN NO EVENT SHALL SELLER BE LIABLE FOR LOST PROFITS OR ANY SPECIAL, CONSEQUENTIAL OR INCIDENTAL DAMAGES. SELLER SHALL NOT BE RESPONSIBLE FOR INSTALLATION, DISMANTLING OR

REINSTALLATION COSTS OR CHARGES. No Action, regardless of form, may be brought against Seller more than 12 months after a cause of action has accrued. The goods returned under warranty to Seller's factory shall be at Buyer's risk of loss, and will be returned, if at all, at Seller's risk of loss.

Buyer and all users are deemed to have accepted this LIMITATION OF WARRANTY AND LIABILITY, which contains the complete and exclusive limited warranty of Seller. This LIMITATION OF WARRANTY AND LIABILITY may not be amended, modified or its terms waived, except by writing signed by an Officer of Seller.

**Service Policy**

Knowing that inoperative or defective instruments are as detrimental to TSI as they are to our customers, our service policy is designed to give prompt attention to any problems. If any malfunction is discovered, please contact your nearest sales office or representative, or call TSI at (800) 874-2811 (USA) or (001 651) 490-2811 (International).

# CONTENTS

<b>SAFETY INFORMATION .....</b>	<b>V</b>
Laser Safety .....	v
Labels .....	vi
Description of Caution/Warning Symbols .....	vii
Caution .....	vii
Warning .....	vii
Caution and Warning Symbols .....	vii
Reusing and Recycling .....	vii
<b>CHAPTER 1 UNPACKING AND PARTS IDENTIFICATION .....</b>	<b>1</b>
Unpacking the DustTrak DRX Aerosol Monitor .....	1
Parts Identification for the DustTrak DRX Desktop Aerosol Monitor Model 8533 .....	6
Parts Identification for the DustTrak II Desktop Aerosol Monitor Model 8533EP .....	7
External Pump Module (8533EP only) .....	7
Parts Identification for the DustTrak DRX Handheld Aerosol Monitor Model 8534 .....	8
<b>CHAPTER 2 SETTING UP .....</b>	<b>9</b>
Supplying Power to the DustTrak DRX Aerosol Monitor .....	9
Installing the Batteries in 8533/8533EP Desktop .....	9
Installing the Batteries in 8534 Handheld .....	9
Connecting the External Pump to DustTrak Model 8533EP .....	10
Using the AC Adapter to Run Instrument .....	12
Battery Charging .....	12
Inlet Cap .....	12
Instrument Setup .....	13
Connecting to the Computer .....	13
Installing TrakPro™ Data Analysis Software .....	13
Connecting Analog/Alarm Output .....	14
Wiring the Analog Output .....	14
Wiring the Alarm .....	15
<b>CHAPTER 3 OPERATION .....</b>	<b>17</b>
Getting Started .....	17
For Model DustTrak 8533EP only .....	17
Setup Menu .....	20
Zero Cal .....	21
Flow Cal .....	22
User Cal .....	23
Alarm .....	29
Analog .....	32
Settings .....	33
Run Mode .....	35
Survey Mode .....	36
Manual Mode .....	37
Log Mode (1–5) .....	38

Taking Mass Concentration Measurements .....	39
Screen Regions .....	40
Stats .....	41
Graphing .....	43
Viewing Data .....	45
Title Bar .....	46
<b>CHAPTER 4 MAINTENANCE.....</b>	<b>47</b>
Maintenance Schedule .....	47
Zeroing Instrument.....	48
Cleaning the Inlet.....	48
Cleaning 2.5 µm Calibration Impactor.....	49
Replacing the Internal Filters .....	50
Replacing the Filters in the External Pump Module .....	53
Storage Precautions .....	54
<b>CHAPTER 5 TROUBLESHOOTING.....</b>	<b>55</b>
<b>APPENDIX A SPECIFICATIONS .....</b>	<b>61</b>
<b>APPENDIX B DRX ADVANCED CALIBRATION .....</b>	<b>63</b>
Option 1: Serial Gravimetric Calibration.....	63
Step 1: PCF Calibration .....	63
Step 2: SCF Calibration .....	63
Option 2: Parallel Gravimetric Calibration .....	64
<b>APPENDIX C ZERO MODULE .....</b>	<b>67</b>
<b>INDEX .....</b>	<b>69</b>

These Application Notes can also be found on TSI's web site:

<http://www.tsi.com>

[\*EXPMN-002 DustTrak DRX Theory of Operation.pdf\*](#)

[\*EXPMN-004 DRX-TEOM Comparison.pdf\*](#)

[\*EXPMN-005 DustTrak DRX Standard and Advance Calibration.pdf\*](#)

# Safety Information

## IMPORTANT

There are no user serviceable parts inside the instrument. Refer all repair and maintenance to a qualified factory-authorized technician. All maintenance and repair information in this manual is included for use by a qualified factory-authorized technician.

## Laser Safety

- The Model 8533/8534 DustTrak DRX monitor is a Class I laser- based instrument
- During normal operation, you will **not** be exposed to laser radiation
- Precaution should be taken to avoid exposure to hazardous radiation in the form of intense, focused, visible light
- Exposure to this light may cause blindness

Take these precautions:

- **DO NOT** remove any parts from the DustTrak DRX monitor unless you are specifically told to do so in this manual
- **DO NOT** remove the housing or covers. There are no serviceable components inside the housing



## WARNING

The use of controls, adjustments, or procedures other than those specified in this manual may result in exposure to hazardous optical radiation.



## WARNING

There are no user-serviceable parts inside this instrument. The instrument should only be opened by TSI or a TSI approved service technician.







## WARNING

If the DustTrak monitor is used in a manner not specified by the manufacturer, the protection provided by the equipment may be impaired.

When operated according to the manufacturer's instruction, this device is a Class I laser product as defined by U.S. Department of Health and Human Services standards under the Radiation Control for Health and Safety Act of 1968. A certification and identification label like the one shown below is affixed to each instrument.

# Labels

Advisory labels and identification labels are attached to the instrument.

<p>1. Serial Number Label (bottom)</p>	<p style="text-align: center;"><b>DUSTTRAK™ DRX – Model 8533</b></p> <p>SN 8533080401 </p> <p>MFD JANUARY 2012</p> <p>CLASS I LASER PRODUCT COMPLIES WITH 21 CFR 1040.10 AND 1040.11</p> <p>TSI Inc. 500 Cardigan Road Shoreview, MN 55126 U.S.A. www.tsi.com</p> <p> </p> <p style="text-align: right;">⎓ 24V – 2.5A Made in USA</p>
<p>2. Laser Radiation Label (internal)</p>	<p style="text-align: center;"><b>DANGER!</b></p> <p style="text-align: center;">VISIBLE LASER RADIATION WHEN OPEN. AVOID DIRECT EXPOSURE TO BEAM</p> <p style="text-align: center;">WARNING: NO USER SERVICABLE PARTS INSIDE. REFER SERVICING TO QUALIFIED PERSONNEL</p>
<p>3. Battery label</p>	<div style="text-align: center; border: 2px solid black; padding: 10px; background-color: yellow; margin-bottom: 10px;"> <p><b>!!WARNING!!</b></p> <p>THIS INSTRUMENT WAS DESIGNED TO USE ONLY TSI SUPPLIED BATTERIES, PN 801680</p> </div> <p style="text-align: center;">or</p> <div style="text-align: center; border: 2px solid black; padding: 10px; background-color: yellow;"> <p><b>!!WARNING!!</b></p> <p>THIS INSTRUMENT WAS DESIGNED TO</p> <p>USE ONLY TSI SUPPLIED BATTERY, PN 801681</p> </div>
<p>4. European symbol for non- disposable item. Item must be recycled.</p>	



## Description of Caution/Warning Symbols

Appropriate caution/warning statements are used throughout the manual and on the instrument that require you to take cautionary measures when working with the instrument.

### Caution



#### Caution

Failure to follow the procedures prescribed in this manual might result in irreparable equipment damage. Important information about the operation and maintenance of this instrument is included in this manual.

### Warning



#### WARNING

Warning means that unsafe use of the instrument could result in serious injury to you or cause damage to the instrument. Follow the procedures prescribed.

## Caution and Warning Symbols



The following symbols may accompany cautions and warnings to indicate the nature and consequences of hazards:

	Warns that the instrument contains a laser and that important information about its safe operation and maintenance is included in the manual.
	Warns that the instrument is susceptible to electro-static discharge (ESD) and ESD protection should be followed to avoid damage.
	Indicates the connector is connected to earth ground and cabinet ground.

## Reusing and Recycling



As part of TSI Incorporated's effort to have a minimal negative impact on the communities in which its products are manufactured and used:

-  Do **not** dispose of used batteries in the trash. Follow local environmental requirements for battery recycling.
-  If instrument becomes obsolete, return to TSI for disassembly and recycling.

*(This page intentionally left blank)*





# Chapter 1

## Unpacking and Parts Identification





Carefully unpack the Model 8533/34 DustTrak DRX Aerosol Monitor from the shipping container. Use the tables and illustrations below to make certain that there are no missing components. Contact TSI immediately if anything is missing or damaged.

### Unpacking the DustTrak DRX Aerosol Monitor



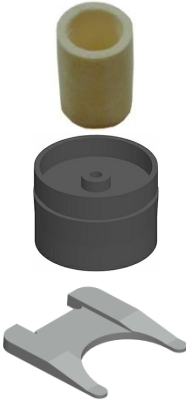

Compare all the components you received with those listed in the table below. If any parts are missing, contact TSI.

Item	Qty	Part Number	Description
 <i>or</i> 	1	8533  8534	Desktop DRX  Handheld DRX
	1	801670  801669	Desktop DRX Carrying Case Handheld DRX Carrying Case
	1	1090014	Data Analysis Software CD- ROM

Item	Qty	Part Number	Description
	1	800663	Zero Filter
 <p style="text-align: center;"><i>or</i></p> 	1	801680  801681	6600 mAh Lithium Ion Rechargeable Battery (Desktop)  Rechargeable lithium ion battery (Handheld)
	1	1303740	USB cable
	1	801652	Analog/alarm output cable (Desktop models only)
	1	6001898	Operation and Service Manual
	1	N/A	Calibration Certificate

Item	Qty	Part Number	Description
	1	801688	Conductive Tubing
	1	801668	Filter removal tool (Spanner Driver)
	4	801673	<p>Spare Internal Filter Elements Desktop Model Only</p> <p>37-mm filter includes: Filter body top Filter body bottom Mesh Screen</p> <p>Comes with 37-mm cartridge opening tool.</p>
	8	801666	Spare Internal Filters Handheld Model Only
	1	801671	<p>Calibration Impactor Kit PM<sub>2.5</sub> which includes: Impactor top Impactor bottom Impaction plate</p>

Item	Qty	Part Number	Description
	1	801692  801694	Power Supply – Desktop  Power Supply - Handheld
	1	801685	Battery Charger, 2-Bay, Battery 801680 for Desktop DustTrak monitor ( <i>optional</i> )
	1	1801686	Battery Charger, Battery 801681 for Handheld DustTrak monitor ( <i>optional</i> )
	2	N/A	Stylus When shipped, one stylus will be in the accessory bag, the second stylus is attached to instrument.
	1	3012094	Screwdriver, dual ended. (For Handheld Models only)
	1	801674	Impactor Oil

Item	Qty	Part Number	Description
	2	801698	Inlet cap When shipped, one inlet will be in the accessory bag, the second inlet is attached to instrument.
	1	801675	External Pump Kit <i>for 8533EP only</i>
	2	801795	DustTrak II/DRX External Pump Service Kit <i>for 8533EP only</i>
	1	801797	External Pump Power Cable (to DustTrak monitor) <i>for 8533EP only</i>
	1	801798	External Pump Flow Tube (to DustTrak monitor) <i>for 8533EP only</i>  Exhaust Adapter, DustTrak monitor <i>for 8533EP only</i>

# Parts Identification for the DustTrak DRX Desktop Aerosol Monitor Model 8533

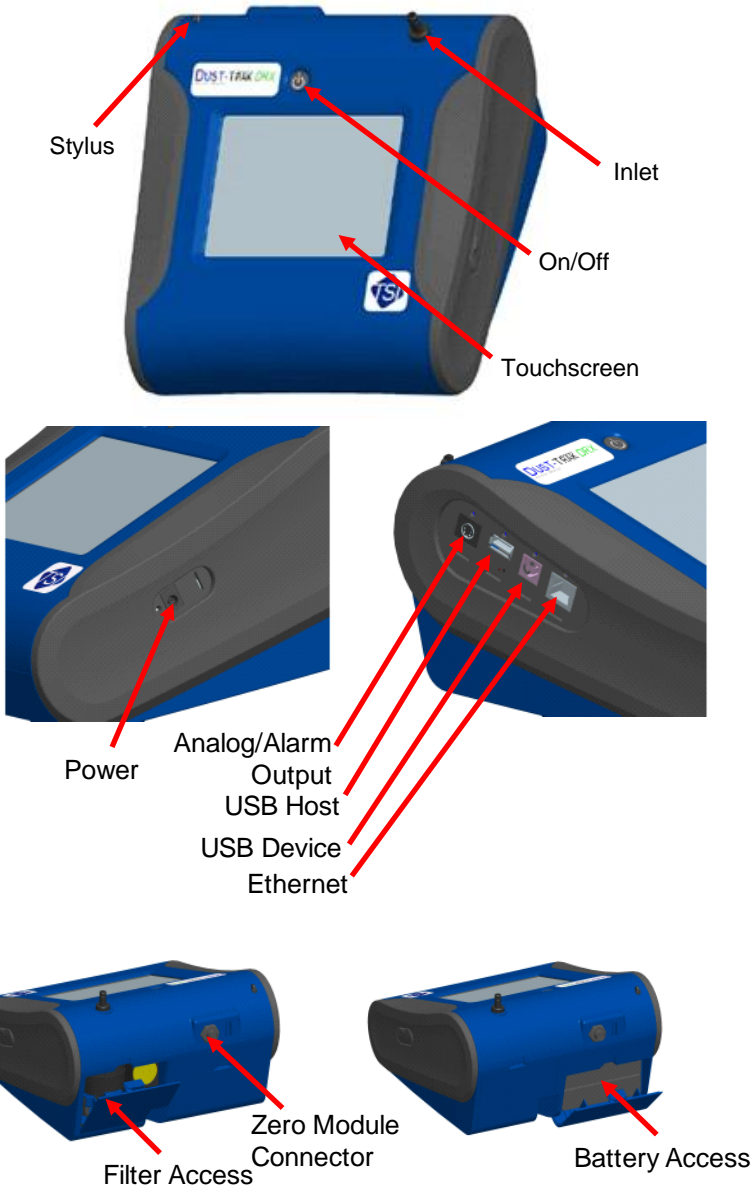

**Figure 1-1: Features on Desktop Model**



# Parts Identification for the DustTrak II Desktop Aerosol Monitor Model 8533EP

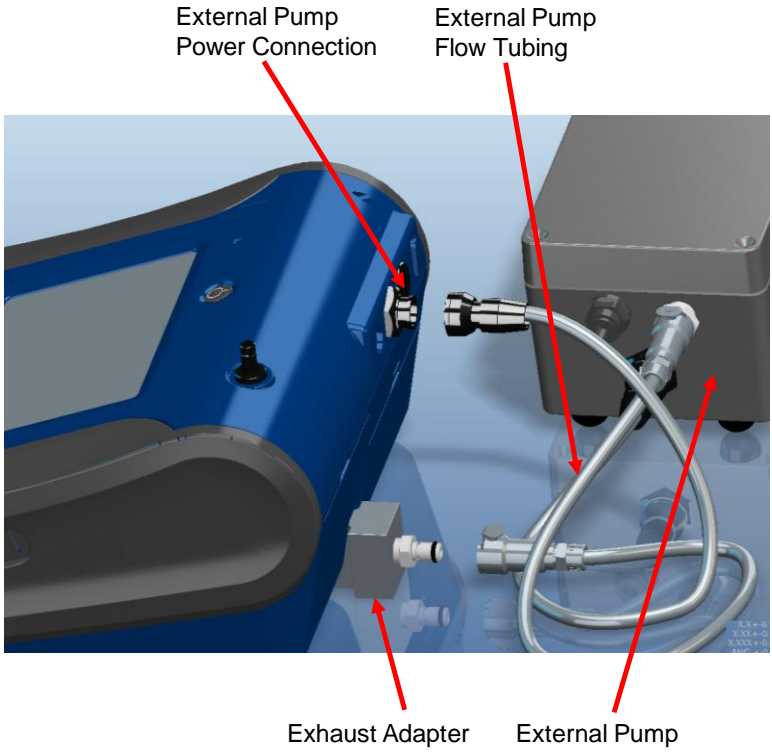

## External Pump Module (8533EP only)

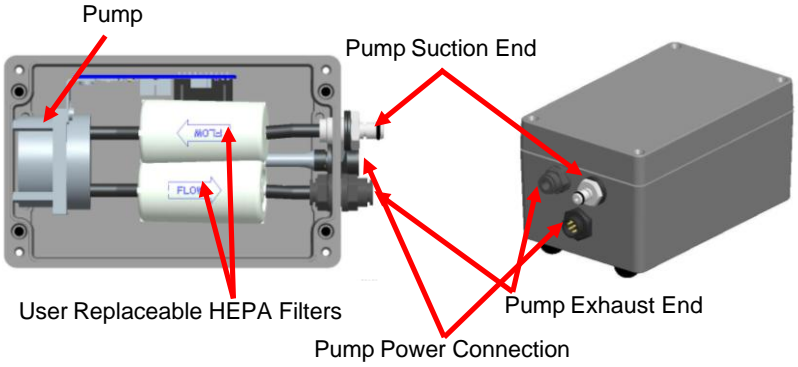

**Figure 1-2: Features on Desktop Model 8533EP**

# Parts Identification for the DustTrak DRX Handheld Aerosol Monitor Model 8534

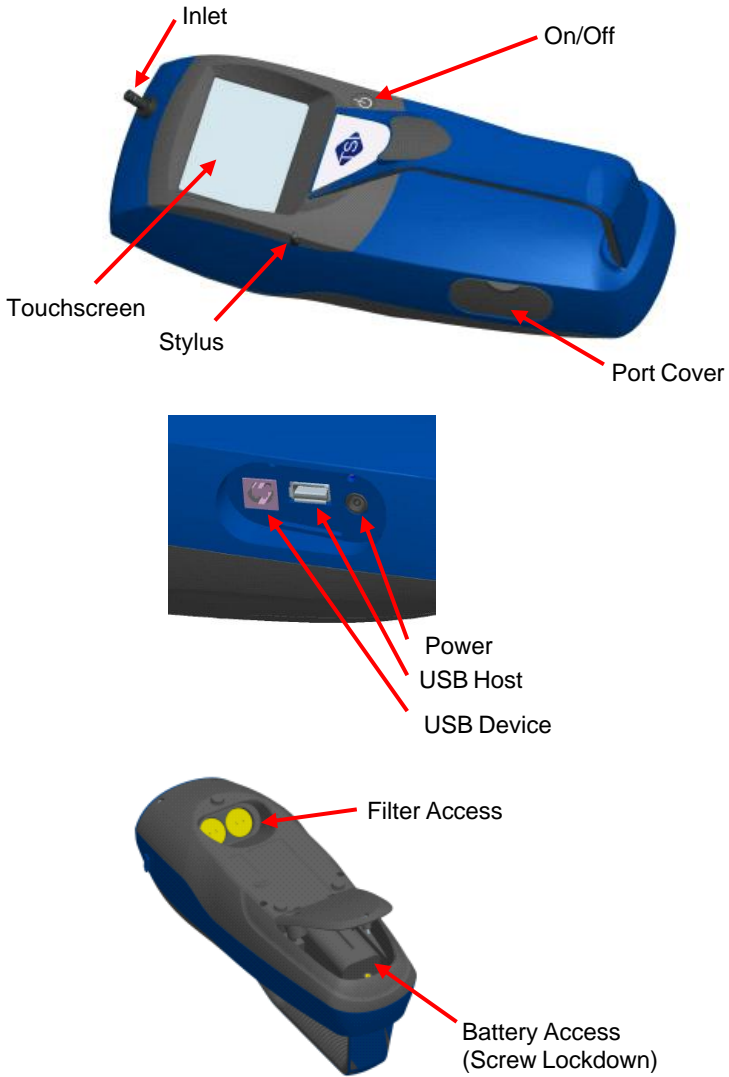

**Figure 1-3: Features on Handheld Model**

# Chapter 2

## Setting Up

---

### Supplying Power to the DustTrak DRX Aerosol Monitor

The Model 8533 and 8534 DustTrak DRX Aerosol Monitor must be powered by either batteries or using the external AC adapter.



#### WARNING

The instrument has been design to be used with batteries supplied by TSI. Do **not** use a substitute.

Disposing of old batteries must be recycled in accordance with the local environmental regulations.



#### WARNING

Do **not** use non-rechargeable batteries in this instrument. Fire, explosions, or other hazards may result.

### Installing the Batteries in 8533/8533EP Desktop

Remove the battery cover and slide one or two batteries into the battery slots. A single battery can be put into either slot. Orient the batteries with the label side facing up (see Figure 2-1).

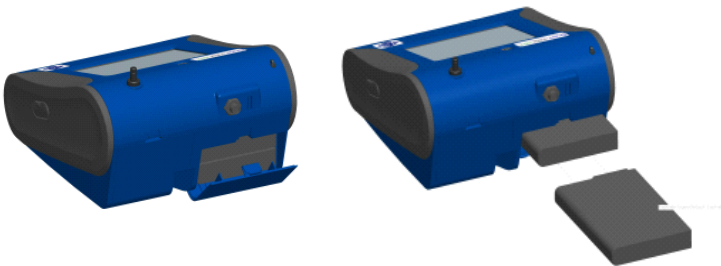
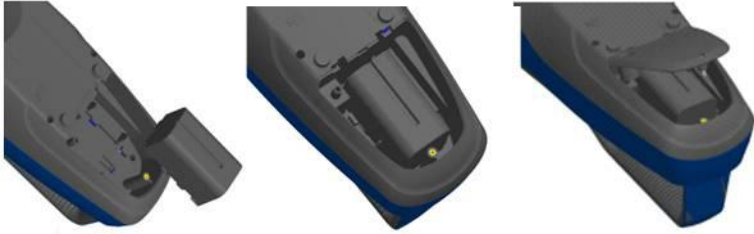

Figure 2-1: Batteries into Desktop Unit

### Installing the Batteries in 8534 Handheld

Remove the battery cover by loosening captured screw on the bottom of the unit. Orient battery with brass connectors facing forward. Insert battery into cavity and slide forward to engage into pins. Replace the battery cover and secure by tightening screw (see Figure 2-2).



**Figure 2-2: Batteries into Handheld Unit**

### **Connecting the External Pump to DustTrak Model 8533EP**

The Model 8533EP is a Desktop DustTrak monitor with an external pump. This DustTrak monitor has no internal pump and will not work with any other external pump other than the one provided by TSI (p/n 801675). The Model 8533EP is intended for applications where the DustTrak monitor is operated continuously over extended periods (several days to months) under wide temperature fluctuations (0 to 50°C). The external pump is designed to be more robust for 24/7 operation of the DustTrak monitor and is warranted to operate continuously for one full year or 8760 hours. The Model 8533EP is ideal for fugitive dust monitoring.

The pump and the DustTrak monitor come separately and require assembly. Follow the steps below to connect the pump with the Model 8533EP DustTrak monitor.



#### **WARNING**

Turn the DustTrak monitor OFF before connecting the external pump. Turn the DustTrak monitor ON only after connecting the External Module.

1. Connect the pump end of the quick connect to the pump module (see Figure 2-3).



**Figure 2-3: Connect Pump End of Quick Connect to Pump Module**

2. Likewise, plug one end of the power connector to the pump module as shown above. Turn the power connector until it clicks and locks in place. This prevents the connector from disconnecting due to vibration or movement.
3. Connect the exhaust adapter to the exhaust of the DustTrak monitor (see Figure 2-4).



**Figure 2-4: Connect Exhaust Adapter to Exhaust of DustTrak Monitor**

4. Connect the other end of the flow tubing to the exhaust adapter of the DustTrak monitor.
5. Connect the other end of the power connector to the DustTrak monitor (see Figure 2-5).

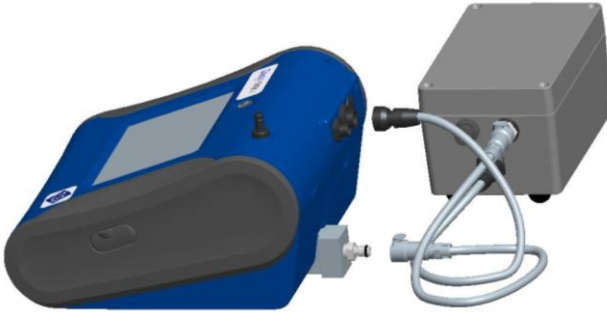

**Figure 2-5: Connect Power Connector to DustTrak Monitor**



**WARNING**

The Pump module design does not allow for installation outdoors without any protection from the elements. Always operate it within an enclosure.

The DustTrak external pump module does not require an A/C adapter. It is always powered off the DustTrak monitor.

### Notes

1. The power connector and the flow quick connect “click” when securely connected. The power connector must be rotated clockwise past the locking pin.
2. Do **not** hot-plug the External Pump Module when the DustTrak monitor is turned ON. Always connect the External Pump module first and then turn the DustTrak monitor ON.
3. TSI recommends that the DustTrak monitor with the external pump be operated in the Model 8535 Environmental Enclosure.
4. TSI recommends that the pump module be operated when mounted on its feet and avoid operating at other orientations as much as possible.
5. Pump module and the DustTrak monitor should be at the same electrical potential.
6. The additional port on the external pump module is where the pump exhausts the flow. For applications where the DustTrak monitor is sampling from a chamber or a duct at pressures significantly different from the ambient, TSI recommends plumbing the exhaust of the external pump back in to the chamber/duct.

## Using the AC Adapter to Run Instrument

The AC adapter allows you to power the DustTrak monitor from an AC wall outlet. When using the AC adapter, the batteries (if installed) are bypassed.

## Battery Charging

This instrument will charge the Lithium Ion battery packs. Insert the batteries into the battery compartment, plug the instrument into AC power, and turn the instrument on. Batteries will charge only when the instrument is on and in stand-by mode. Batteries will not charge if the instrument is turned off or is actively taken measurements. Charging will stop when the batteries are fully charged.



### WARNING

When Charging Battery the ambient temp must **not** exceed 42°C.

## Inlet Cap

When using the DustTrak monitor to sample environmental air, the inlet cap should be put over the instrument. This cap will keep large objects from dropping into and plugging the inlet. The cap will also keep direct light from shining into the chamber and skewing the results.

The inlet cap can simply be pressed onto the instruments inlet.



Figure 2-6: Putting on Inlet Cap

## Instrument Setup

The DustTrak DRX monitor can be connected to a computer to download data and upload sampling programs.

### Connecting to the Computer

Connect the USB host port of a Microsoft® Windows®-based computer to the USB device port on the side of the DustTrak monitor.

### Installing TrakPro™ Data Analysis Software

TrakPro software can preprogram the DustTrak monitor, download data, view and create raw data and statistical reports, create graphs, and combine graphs with data from other TSI instruments that use TrakPro software. The following sections describe how to install the software and set up the computer.

#### Note

To use TrakPro software with the DustTrak Aerosol Monitor, the PC must be running Microsoft Windows® and the computer must have an available Universal Serial Bus (USB) port.

1. Insert the TrakPro Data Analysis Software CD into the CD-ROM drive. The install screen starts automatically.

#### Note

If the software does not start automatically after a few minutes, manually run the program listed on the label of the CD using the **Run** command on the Windows Start Menu.

2. Follow the directions to install TrakPro software.

---

®Microsoft and Windows are registered trademarks of Microsoft Corporation.

TrakPro software contains a comprehensive installation guide. TSI recommends printing out this guide prior to starting the TrakPro software installation on your computer, so it may be consulted during the installation. The TrakPro Software manual is located in the “Help” file in TrakPro software. There is no separately printed TrakPro Data Analysis software manual.

## Connecting Analog/Alarm Output

The Analog/Alarm Output Cable plugs into the alarm connection on the side of the instrument. This feature is on the desktop models (II, II HC and 8533) only.

The cable contains a 4-pin, mini-DIN connector. The pin-outs for the connector and the wiring for the cable are shown below.

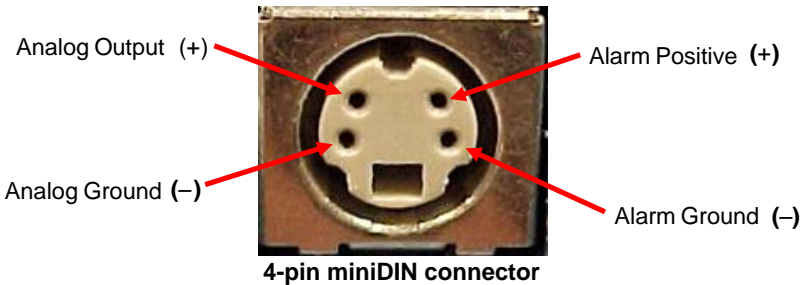

Cable Wiring Diagram	
Brown Wire	Analog Ground
Orange Wire	Analog Out
Red Wire	Alarm (+)
White Wire	Alarm (-)
Black Wire	Shield

**Figure 2-7: Cable Wiring Diagram**

## Wiring the Analog Output

- Output voltage: 0 to 5 VDC. With a maximum output of 15 mA.
- Output Current 4 mA to 20 mA with a maximum load impedance of 250 ohms.
- Correct polarity must be observed (see pin-outs above).

The output cable supplied by TSI (part no. 801652) is labeled with the pin-out wiring diagram. Additional equipment may be needed for making connections to the system that TSI does not supply. It is your responsibility to specify and supply all additional equipment.



## Wiring the Alarm

System specifications:

- Maximum voltage: 15 VDC (**DO NOT USE AC POWER**)
- Maximum current: 1 Amp
- Correct polarity must be observed (see pin-outs above)
- The alarm switch, located inside the DustTrak monitor must be located on the ground side of the alarm system.



### WARNING

The DustTrak monitor Alarm Output function should **not** be used to detect hazardous conditions or to provide an alarm for protecting human life, health or safety.



### Caution

The alarm switch must **not** be wired to AC power! Failure to install the user alarm properly could damage the DustTrak instrument and/or void the instrument warranty! Please read and follow all instructions before wiring or operating the user alarm.



### WARNING

When connected to the analog out and alarm out connector, you **must** use safety certified equipment and/or power sources.

*(page intentionally left blank)*

# Chapter 3

## Operation

---

### Getting Started

The **START UP** screen is displayed initially when the instrument is turned on, following the initial TSI logo splash screen.

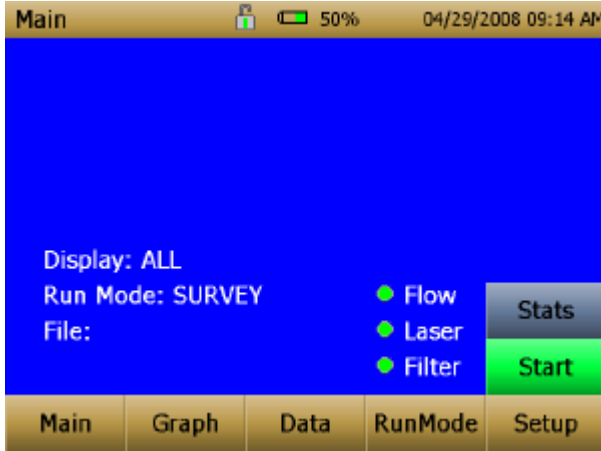

Using a stylus or fingertip, touch the “buttons” on the screen to activate different menus.

### For Model DustTrak 8533EP only



#### **W A R N I N G**

Always setup and operate the DustTrak monitor with External Pump Module with the External Pump Module connected to the DustTrak monitor. Failure to do so will result in communication errors.

Communication errors take place under four different scenarios as follows:

1. When the unit is idle and is **not** connected to the External Pump Module, a warning displays on the Main screen.

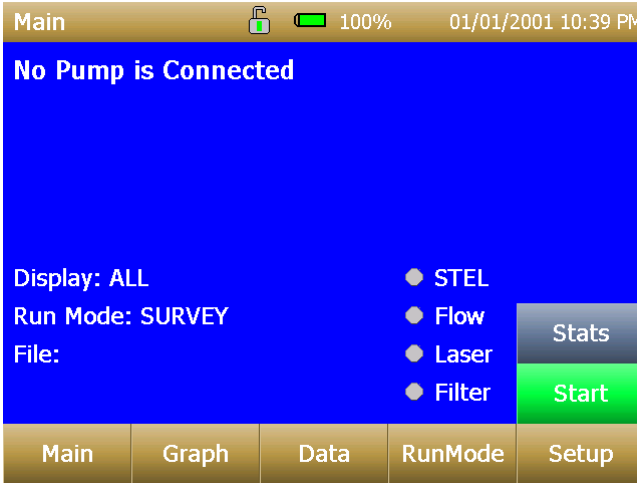

**Note**

“No Pump is Connected” is a sticky error. Even after the warning message, if the External Pump Module is connected to the DustTrak, the error will not disappear until the screen is refreshed. Refresh the screen by going into a different menu and returning to the Main menu.

2. When the unit is **not** connected to the External Pump Module and an attempt is made to start a run by selecting “Start”, an error appears on the Main screen.

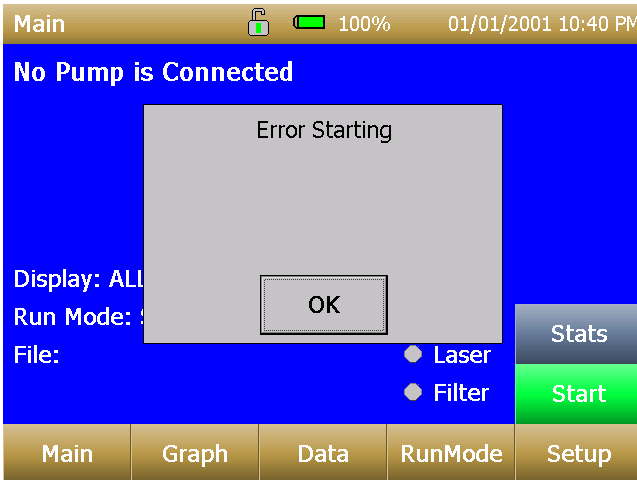

3. If the pump is **not** connected while attempting to perform a Zero Cal, an error appears on the Setup screen.

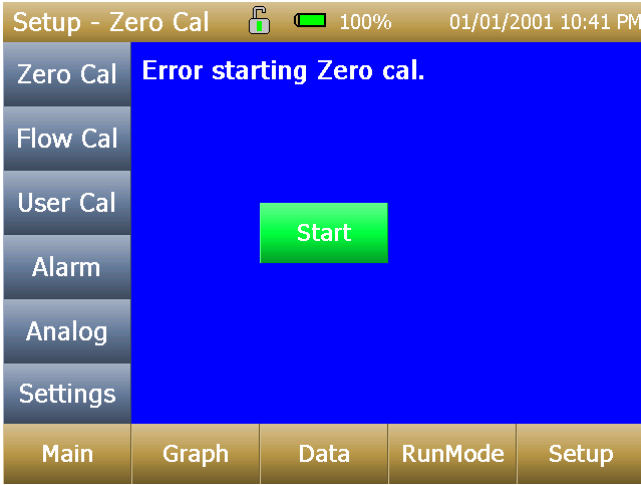

4. If the pump is **not** connected while attempting to perform a Flow Cal, an error appears on the Setup screen.

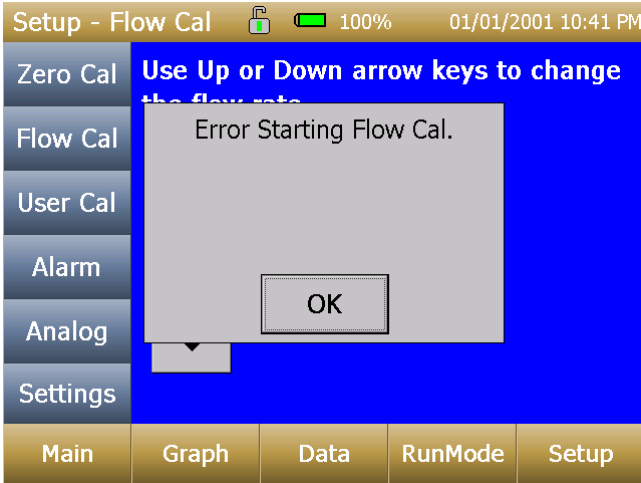

## Setup Menu

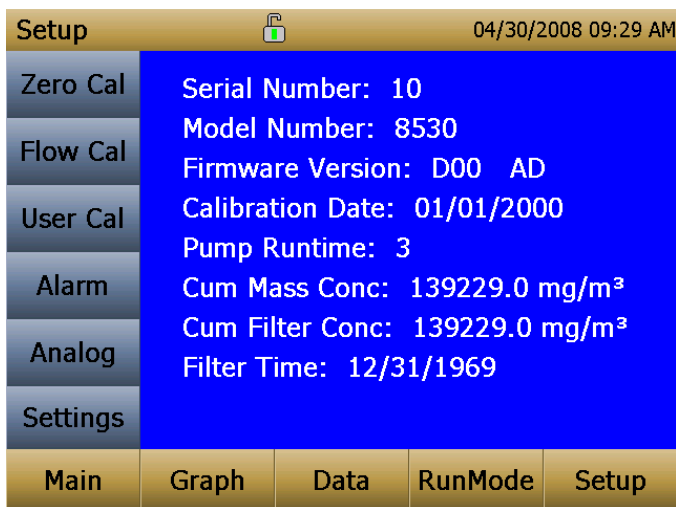

Pressing **Setup** activates the Setup Menu touchscreen buttons along the left edge of the screen. Setup is not accessible when the instrument is sampling.

The main screen of the **Setup** screen displays the following information:

<b>Serial Number</b>	The instruments serial number.
<b>Model Number</b>	The instruments model number.
<b>Firmware Version</b>	Instruments current version of firmware.
<b>Calibration Date</b>	Date of the last factory calibration.
<b>Pump Run Time</b>	Pump running time in hours.
<b>Cum Mass Conc</b>	Amount of mass run through instrument over life.
<b>Cum Filter Conc</b>	Amount of mass run through instrument since last filter change.
<b>Filter Time</b>	Date of last filter change.

## Zero Cal

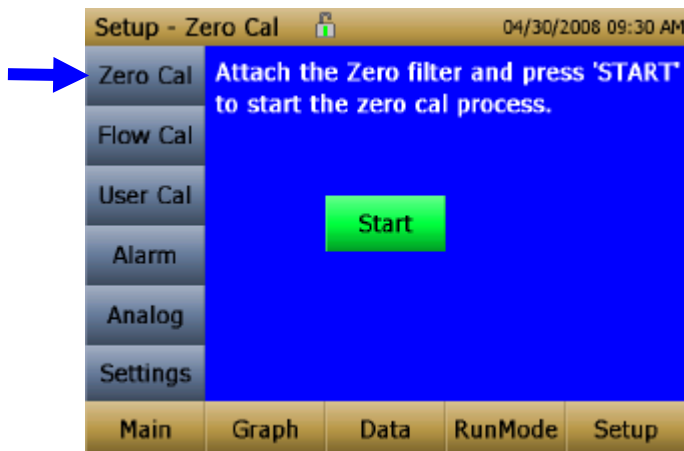

Run **Zero Cal** the first time the instrument is used and repeat prior to every use. Zero Cal requires that the zero filter be attached prior to running. Zero Cal must also be performed if the unit is reading negative concentrations. It is not possible for the DustTrak monitor to read negative concentrations. Negative concentrations are a symptom of zero drift.

**Never perform a zero cal without attaching a zero filter.**

1. Press Zero Cal Button
2. Attach Zero Filter
3. Press the **Start** button to start Zeroing process.
4. A count-down clock will appear indicating the time remaining. The screen will indicate "Zero Cal Complete" when done.

Remove filter after zeroing has been completed. The instrument is now zero calibrated and ready for use.

## Flow Cal

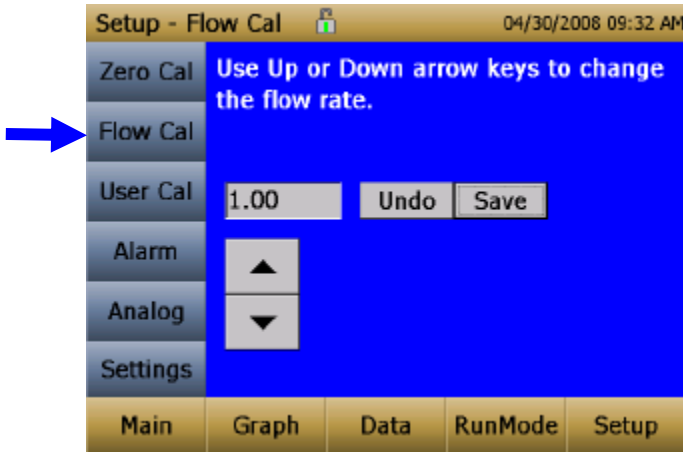

Run **Flow Cal** to change the flow set point. The flow set point is factory set to 3 L/min total flow. 2 L/min of the total flow is measured aerosol flow. 1 L/min of total flow is split off, filtered, and used for sheath flow. There is an internal  $\Delta P$  flowmeter in the DustTrak DRX instrument that controls flow rate to  $\pm 5\%$  of factory setpoint. TSI recommends checking the flows with an external flow reference meter, especially when collecting data. The pump will automatically start when entering the Flow Cal screen.

1. Attach a flow calibrator (reference flow meter) to inlet port. You may use a bubble buret, mass flow meter, dry piston or rotameter as flow measurement devices.
2. Move the arrows up or down to achieve desired flow on the reference flowmeter. Each up or down arrow will change the flow about 1%. Allow time between button presses to let pump change to the new flow rate.
3. Select **Save** once the desired flow rate is achieved. Select **Undo** to return to the factory set point.

### Note

The flow rate can be adjusted from approximately 1.5 to 4.0 L/min. For Model 8533/8534, the FlowCal feature allows you to re-adjust the flow rate to 3.0 L/min. While the flow rate for Model 8533/8534 is fixed at 3.0 L/min, the flow rate for Model 8530/8532 can be changed. This allows for the use of other size selective inlets like cyclones or impactors with Model 8530/8532. No size-selective inlets should be installed on the inlet of Model 8533/8534 during its normal operation.



## User Cal

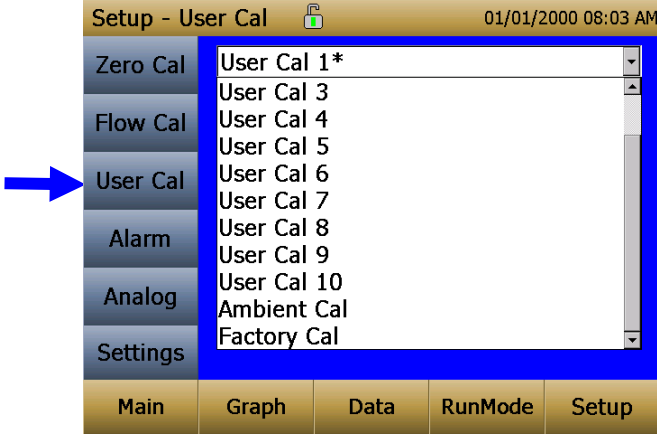

**User Cal** allows you to store and use 10 different calibration factors. In addition, there are two factory defaults, one is the “Ambient Cal” and the other is the “Factory Cal”. The “Ambient Cal” is appropriate for outdoor ambient dust or fugitive dust monitoring. The “Factory Cal” is the calibration to ISO 12103-1, A1 Arizona test dust for which a calibration certificate is provided with the instrument. The “Factory Cal” is appropriate for most workplace aerosol monitoring. The currently active user calibration is highlighted with an asterisk “\*”.

Four variables can be set for each user calibration.

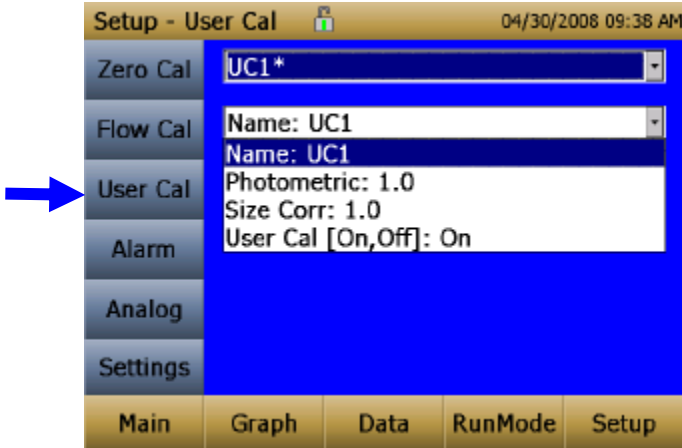

<b>Name</b>	User can rename calibration to a description name.
<b>Photometric</b>	Changes the factory calibration of particle signal, based on Arizona Road Dust, to actual aerosol being measured. See below for sets to set this calibration.
<b>Size Corr</b>	Changes the factory calibration of the particle distribution, based on Arizona Road Dust, to actual aerosol being measured. See below for sets to set this calibration.
<b>User Cal [on,off]</b>	Selecting <b>On</b> will activate current user calibration and deactivate the previously selected user calibration.

The Size and Photometric Calibration factors can be determine using a standard or advanced calibration method. The standard method is quick and easy to perform and works well in most situations. That method is shown below. The advanced method will give the tightest accuracy and is described in [Appendix B](#).

**Standard Calibration Method—Size Correction Factor**

The size correction factor is used to improve the relative accuracy between the 5 mass channels (PM<sub>1</sub>, PM<sub>2.5</sub>, Resp, PM<sub>10</sub>, and Total). The instrument has been optimized in the factory calibration to standard ISO 12103-1, A1 test dust (formerly Arizona Test Dust).

Following the steps below, a size correction factor can be determined for the aerosol of interest to better optimize the 5 mass channels relative accuracy.

**Note:** *The 2.5 µm inlet impactor should be clean before performing the shape calibration. The cleaning procedure is details in the [Maintenance](#) section of this manual.*

1. Select **Size Corr** from the drop down list.

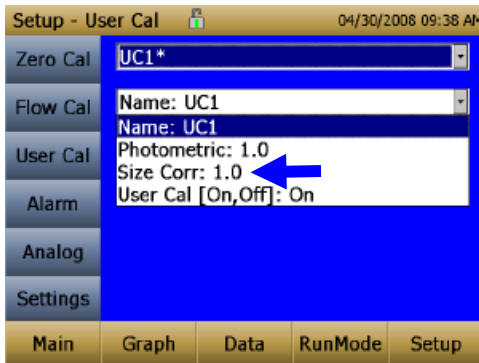

2. Press the **Custom Cal** button.

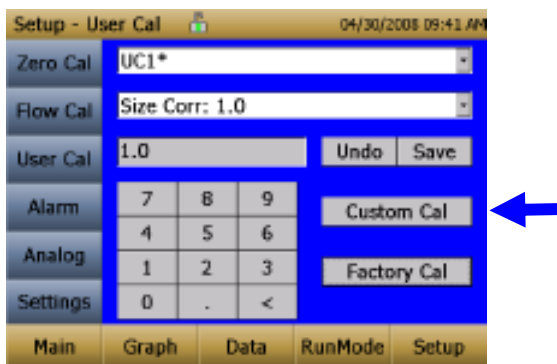

3. Follow the on screen steps to determine the size Corr. The PM<sub>2.5</sub> impactor is required for this step.

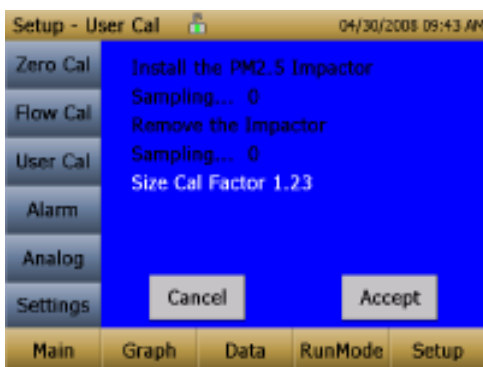

4. Save the calculated value.

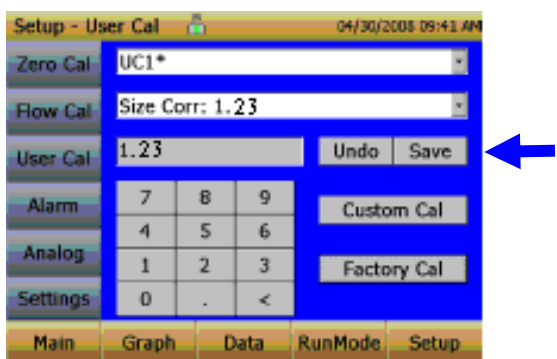

## Taking a Gravimetric Sample Using the DustTrak Monitor

When sampling with the DustTrak monitor, you can simultaneously take a gravimetric sample either for custom calibration of the DustTrak monitor or for collecting the sample on to the gravimetric filter downstream of the DustTrak monitor without a need for additional gravimetric sampling pump and filter assembly. To accomplish this, follow the instructions given below:

1. Setup the DustTrak monitor to sample how long you want the sample run time to be. The following example shows a sample for 8 hours.
2. Under RunMode menu, put the instrument in Manual Log (Manual Logging is reviewed later in this section), which will enable you to start and stop the pump at any time you choose.
3. Set the logging interval. One minute (i.e., "01:00") is a good choice.
4. Make sure you have a preweighed 37-mm gravimetric filter cassette loaded into the DustTrak monitor. See Chapter 4, "[Replacing the Internal Filters](#)" on how to access the filter (see [Figure 4-8](#)) and replace it.

### Note

Use only the conductive plastic filter cassette holder (SKC Part# 225-308).

5. Under the Setup Menu, make sure the DustTrak monitor is set to the desired flow rate. For DustTrak II Model 8530, the flows can be varied from 1.7 to 4 L/min for use with various inlet conditioners. For DustTrak DRX Model 8533, **the flow cannot be changed**. The flows for DustTrak II monitor can be changed by changing the default flow calibration setpoint from 1.0 to any value between 0.5 to 1.5 in the span adjustment. An external flowmeter is needed to measure the total flow. Flow can be changed by clicking on the UP or DOWN arrow keys shown below:

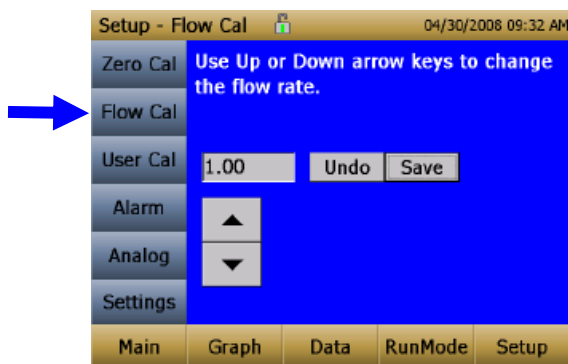

6. Conduct a preflow calibration on the DustTrak monitor using the same kind of sample media you will sample with. Now, attach the sample media you intend to sample with and start sampling aerosol for the desired time. After the desired run time, stop the sampling. Remove the filter from the DustTrak monitor and follow your laboratory's criteria for

filter post weight. Conduct a post-flow calibration with the same sample media done with the pre-flow calibration and determine if these flow calibrations are within  $\pm 5\%$  of each other. If they are, use the following to calculate the actual flow rate for the DustTrak monitor. The laboratory will need the following information to calculate mass concentration in  $\text{mg}/\text{m}^3$ :

- Total sample time in minutes.
  - Flow rate—flow rate of the DustTrak monitor used for gravimetric analysis is only  $2/3$  the total flow since  $1/3$  of the flow is used as sheath flow.
  - Total liters of air sampled = total sample time x flow rate.
7. Using this information the laboratory can determine the concentration using the following formula:

$$\text{Concentration, } \frac{\text{mg}}{\text{m}^3} = \frac{\left\{ \begin{array}{l} \text{Filter Post Weight (mg)} - \\ \text{Filter Pre Weight (mg)} \end{array} \right\}}{\left\{ \begin{array}{l} \text{DustTrak™ Monitor} \\ \text{Flow Rate (L/min)} \end{array} \right\} \times \frac{2}{3} \times \frac{1}{1000}} \times \text{Total Sample Time (min)}$$

**Note**

The flow rate used for gravimetric analysis is only  $2/3$  the total flow since  $1/3$  of the flow is used as sheath flow.

8. For instructions on how to calibrate the DustTrak monitor using this data, see section below on [“Determining the Calibration Factor for a Specific Aerosol”](#).

**Standard Calibration Method—Photometric Calibration Factor**

In most situations, the DustTrak monitor with its built-in data logging capability can provide very good information on how the concentration of an aerosol changes for different processes over time. Factory calibration to the respirable fraction of standard ISO 12103-1, A1 test dust is fairly representative of a wide variety of workplace aerosols. Because optical mass measurements are dependent upon particle size and material properties, there may be times in which a custom calibration would improve your accuracy for a specific aerosol.

Determining a aerosol specific photometric calibration requires that you determine a true mass concentration (e.g., gravimetric analysis) for the aerosol you want to measure. The true mass concentration is used to calculate the custom calibration factor for that aerosol. Once you have a custom calibration factor, you can reuse it each time you make measurements in the same aerosol environment.

**Determining the Calibration Factor for a Specific Aerosol**

The DustTrak DRX monitor is factory calibrated to the respirable fraction of standard ISO 12103-1, A1 test dust. The DustTrak monitor can be easily calibrated to any arbitrary aerosol by adjusting the custom calibration factor.

The DustTrak monitor's custom calibration factor is assigned the value of 1.00 for the factory calibration to standard ISO test dust. This procedure describes how to determine the calibration factor for a specific aerosol. Using the value of 1.00 will always revert back to the factory calibration.

To determine a new calibration factor you need some way of accurately measuring the concentration of aerosol, hereafter referred to as the reference instrument. A gravimetric analysis is often the best choice, though it is limited to nonvolatile aerosols.

To make an accurate calibration you must simultaneously measure the aerosol concentration with the DustTrak monitor and your reference instrument.

1. Zero the DustTrak DRX monitor.
2. Put the instrument in Manual Log (Manual Logging is reviewed later in this section).
3. Set the logging interval. One minute (i.e., "01:00") is often a good choice.
4. Co-locate the DustTrak DRX monitor and the reference sampler together so that they are measuring from the same area.
5. Start sampling aerosol with both instruments at the same time.

**Note**

Greater accuracy will be obtained with longer samples. The time you permit for sampling often depends on the reference instrument and characteristics of the measured aerosol. It may take some time to collect sufficient aerosol onto a filter cassette for accurate gravimetric analysis. Refer to instructions of your reference instrument for sampling times.

6. Stop sampling with both instruments at the same time.
7. Record the DustTrak monitor average concentration by viewing the sample average in the Data screen. (Data Screen is reviewed later in this chapter.)
8. Determine the mass concentration in  $\text{mg}/\text{m}^3$  from your reference instrument. For gravimetric sampling this means weighing the gravimetric sample.

**Note**

If you used the internal gravimetric filter in the DustTrak Model 8533, the flow rate used to compute the concentration should be 2 L/min, not 3 L/min since only 2 L/min of aerosol flow reaches the filter.

9. Compute the new calibration constant, NewCal, using the following formula:

$$\text{NewCal} = \left( \frac{\text{Reference Concentration}}{\text{DustTrak Concentration}} \right) \cdot \text{CurrentCal}$$

10. Select **Photometric** from the User Cal drop down selection and enter the NewCal factor using the onscreen controls.

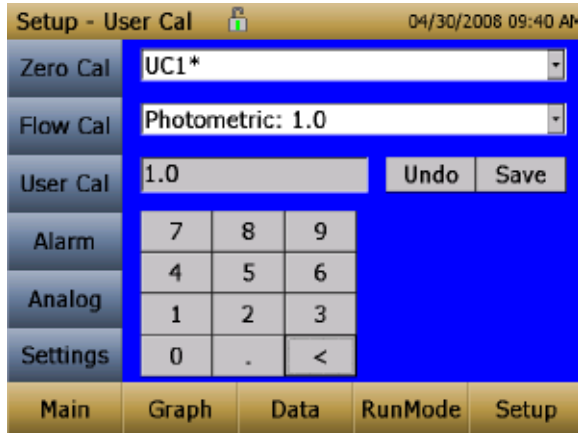

## Alarm

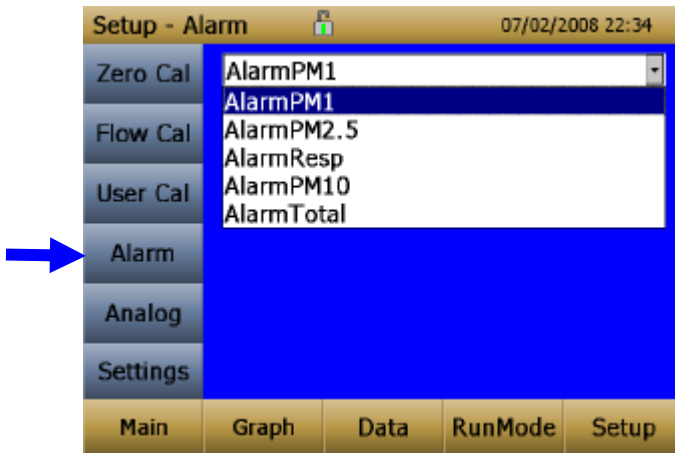

Alarm allows you to set alarm levels on any of the 5 mass channels PM<sub>1</sub>, PM<sub>2.5</sub>, RESP, PM<sub>10</sub> and Total. However, the alarm functioning is determined by the logging interval. The alarm will turn ON only if the average concentration over the logging interval exceeds the set point. If the logging interval is too long and the concentration exceeds the set point and stays at that level, the alarm will not turn ON until after the logging interval has passed. Likewise, the alarm will not stop until after the concentration has dropped below 5% of the threshold and after the logging interval has passed.

For each mass channel, an alarm set point level and alarm type can be set.

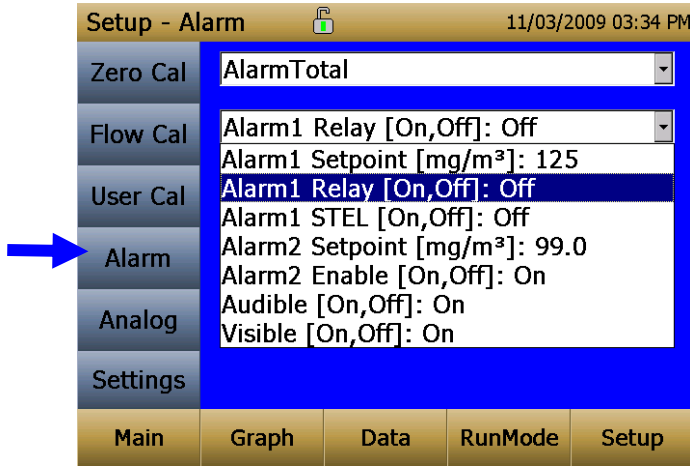



**Note**

The Alarm is dependent on the logging interval. For the DustTrak to alarm as soon as the Alarm Setpoint is exceeded, the logging interval must be set as low as possible (i.e., 1 second or 2 seconds). If a long test duration does not permit setting such a short logging interval, use the STEL alarm instead. The STEL is always based on 1 second concentrations and is independent of the logging interval. For more details on the STEL alarm, see section below on STEL.

In Survey mode, the alarm is dependent on the time constant.

<b>Alarm1 Setpoint [mg/m<sup>3</sup>]</b>	<p>The alarm1 setpoint is the mass concentration level upon which the alarm1 is triggered.</p> <p>Alarm will trigger if the mass concentration, taken at the logging interval, rises above the setpoint.</p> <p><b>Note:</b> Alarm 2 must be lower than Alarm 1 when both alarms are enabled.</p>
<b>Relay1 [On, Off]</b>	<p>When the relay alarm is turned on, unit will close relay switch when Alarm1 level is surpassed.</p> <p>Relay alarm can only be linked to one mass channel at a time.</p> <p>Relay selection is available on the 8533 desktop model only.</p>



<b>STEL 1 [On, Off]</b>	<p>When the STEL alarm is turned on, STEL data will be collected when Alarm1 level is surpassed.</p> <p>STEL alarm can only be linked to one mass channel at a time.</p> <p>STEL selection is available on the 8533 desktop model only.</p> <p>See following STEL Note.</p>
<b>Alarm2 Setpoint [mg/m<sup>3</sup>]</b>	<p>The alarm2 setpoint is the mass concentration level upon which the alarm2 triggers.</p> <p>Alarm triggers if the mass concentration, taken at the logging interval, rises above the setpoint.</p> <p><b>Note:</b> <i>Alarm 2 must be lower than Alarm 1 when both alarms are enabled.</i></p>
<b>Alarm2 Enable [On, Off]</b>	<p>Enables Alarm2 to be logged and will activate the Audible or Visible alarms if they are enabled.</p>
<b>Audible [On, Off]</b>	<p>When the audible alarm is turned on, the instrument will activate internal beeper when Alarm1 or Alarm2 level is surpassed.</p> <p>Audible alarm can only be linked to one mass channel at a time.</p>
<b>Visible [On, Off]</b>	<p>When the visible alarm is turned on, unit will show the alarm icon (Alarm1 , Alarm 2 ) in title bar when Alarm1 or Alarm2 level is surpassed.</p>

### STEL Alarm

STEL stands for **Short Term Exposure Limit**. When a STEL alarm is selected, the instrument will inspect the data on a second by second basis, independent from the selected logging interval. If the mass exceeds the STEL limit, a STEL even triggers and the following actions will be taken.

<b>STEL indicator</b>	The STEL indicator  will show Red on the main screen.
<b>Data</b>	Data will be taken of the STEL alarm channel at a 1 minute logging interval for <b>15 minutes</b> . This data will be stored in a separate file named STEL_XXX, where XXX will be matched to the logged data file. The instrument will also continue to log the mass concentration data at the logging interval selected.
<b>STEL Alarm repeat</b>	If the instrument remains over the STEL limit after the 15 minute interval, or if the instrument exceeds the STEL limit later during the sample period, additional STEL files will be generated.

### Analog

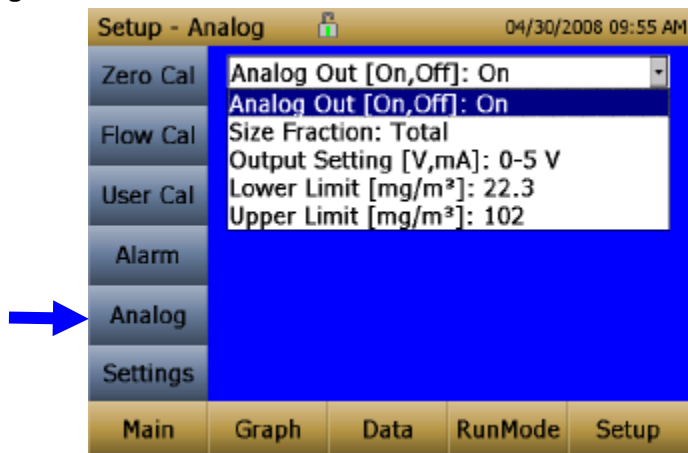

**Analog** setup screen sets the parameters that will drive the analog out port. Applies to the 8533 Desktop model only.

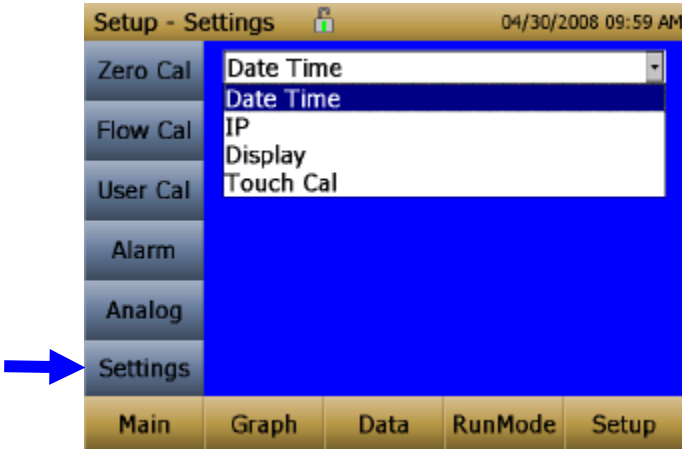

<b>Analog out [On, Off]</b>	Turns analog out port on.
<b>Size Fraction</b>	Selects the size channel that will drive the analog out.
<b>Output Setting [V, mA]</b>	Select between 0 to 5 V and 4 to 20 mA.
<b>Lower Limit [mg/m<sup>3</sup>]</b>	Mass concentration reading of the selected channel that will correspond to 0 V or 4 mA.
<b>Upper Limit [mg/m<sup>3</sup>]</b>	Mass concentration reading of the selected channel that will correspond to 5 V or 20 mA.

### Settings

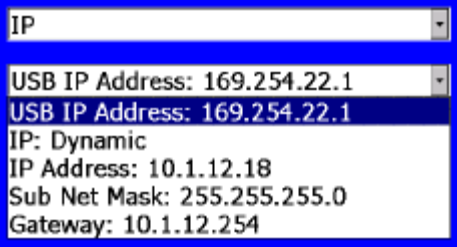

**Settings** screen sets basic unit parameters.

<b>Date Time</b>	<p>Sets current date, current time and date/time format. Time can be set in 12 or 24 hour format. Date can be set in yyyy/dd/mm, yyyy/mm/dd or yyyy/dd/mm.</p>
------------------	--

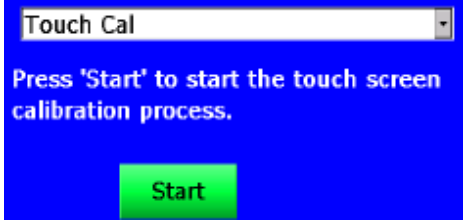
<p><b>IP</b></p>	 <p><b>USB PORT IP Address:</b>  USB IP is the address assigned to the instrument by the NDIS driver. It is shown but cannot be changed.</p> <p><b>Ethernet Port IP parameters:</b>  (Model 8533 Desktop only.)  IP method can be set to static or dynamic.  For static IP, IP address, default gateway, and subnet mask can be set.  For Dynamic, The IP assigned by the network is shown.  This cannot be changed.  See Note below.</p>
<p><b>Display</b></p>	 <p>Switches between blue and white backgrounds.</p>
<p><b>Touch Cal</b></p>	 <p>Calibrates the touch cal screen.</p>

<p align="center"><b>IP Notes</b></p>
<p>After changing the instrument to Dynamic or Static, reboot the instrument.</p> <p>In Dynamic Mode, the unit will show the IP to which is assigned (after being rebooted).</p>

## Run Mode

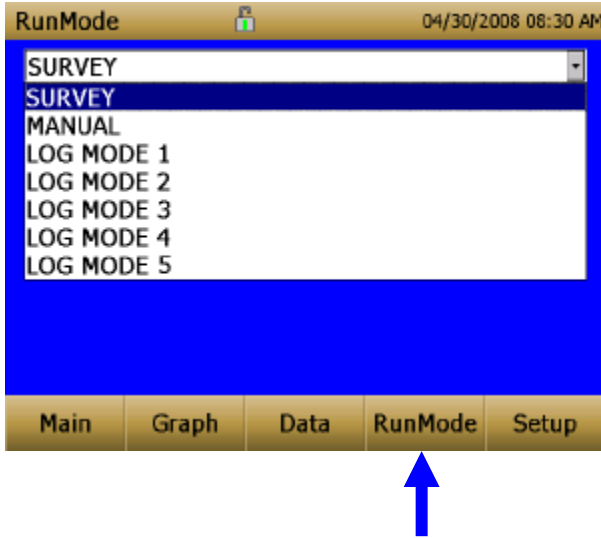

The **RunMode** tab brings up sampling mode options.

Sampling mode options include **Survey Mode**, **Manual Log**, and **Log Mode 1-5**.

<b>Survey</b>	Survey Mode runs a real time, continuous active sample, but does not log data.
<b>Manual</b>	Manual Log sets the instrument to log data for a specified run time
<b>Log Modes</b>	Log Mode starts and stops the instrument at specified times, run for a specified test length, and perform multiple tests of the same length with a specified time period between tests.

## Survey Mode

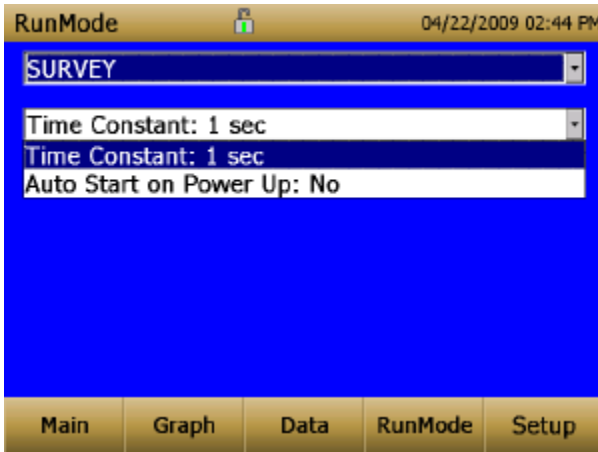

<p><b>Time Constant</b></p>	<p>Time Constant can be set from 1 to 60 seconds. This will control the update rate of the main screen. It is the rolling average of data displayed on the main screen and is not linked to logged data in either Manual or Program Log modes.</p>
<p><b>Auto Start on Power Up</b></p>	<p>When set to “Yes”, unit will start a measurement upon being powered on, if the unit was set to “Survey” when it was turned off.</p> <p>When set to “No”, the unit will be in idle when it is powered on.</p>

## Manual Mode

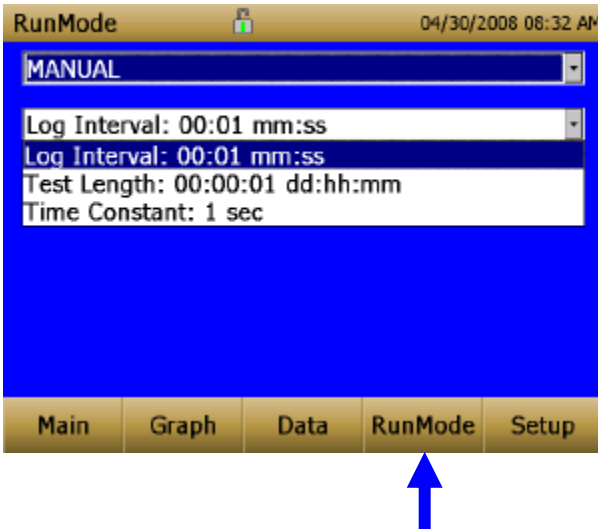

<b>Log Interval</b>	The log interval can be set from 1 second to 60 minutes. It is the amount of time between logged data points.
<b>Test Length</b>	Test length can be set from 1 minute to the limit of the data storage.
<b>Time Constant</b>	Time Constant can be set from 1 to 60 seconds. This will control the update rate of the main screen. It is the rolling average of data displayed on the main screen and is not linked to logged data in either Manual or Program Log modes.

In Manual mode, data will be stored to a file named "*Manual\_XYZ*" where XYZ is an incrementing integer.

## Log Mode (1–5)

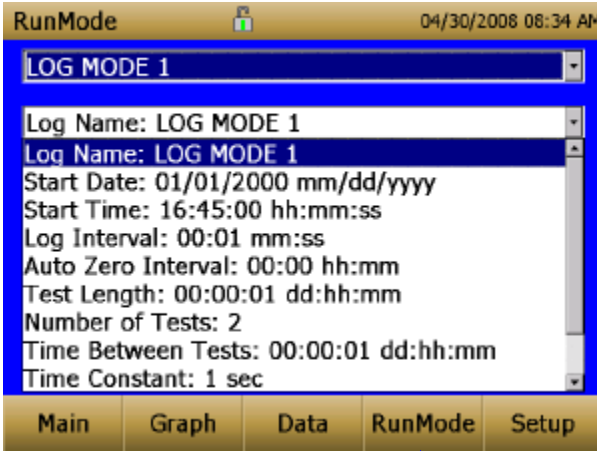

<b>Log Name</b>	Log Name, brings up a virtual keypad to name the Logged Data file.
<b>Start Date</b>	Start Date, select the date the test will start.
<b>Start Time</b>	Start Time, select the time the test will start.
<b>Log Interval</b>	The log interval can be set from 1 second to 60 minutes. It is the amount of time between logged data points.
<b>Auto Zero Interval</b>	Interval between re-zeroing the instrument using the Auto-Zero accessory. Model 8533 desktop only.
<b>Test Length</b>	From 1 minute to the limit of the data storage.
<b>Number of Tests</b>	Number of tests, 1 to 999.
<b>Time between Tests</b>	Time between tests, 1 minute to 30 days.
<b>Time Constant</b>	Time Constant can be set from 1 to 60 seconds. This will control the update rate of the main screen. It is the rolling average of data displayed on the main screen and is not linked to logged data in either Manual or Program Log modes.
<b>Use Start Date</b>	Use Start Date, option to use programmed start date or by pass programmed start date.
<b>Use Start Time</b>	Use Start Time, option to use programmed start time or bypass programmed start time.

In Log mode, data will be stored to a file named “*LogName\_XYZ*” where *LogName* is the user entered log name and *XYZ* is an incrementing integer.



# Taking Mass Concentration Measurements

Measurements are started and controlled from the main screen.

Prior to starting a measurement the instrument should be zeroed from the **Setup** screen and the run mode should be configured and selected from the **RunMode** screen.

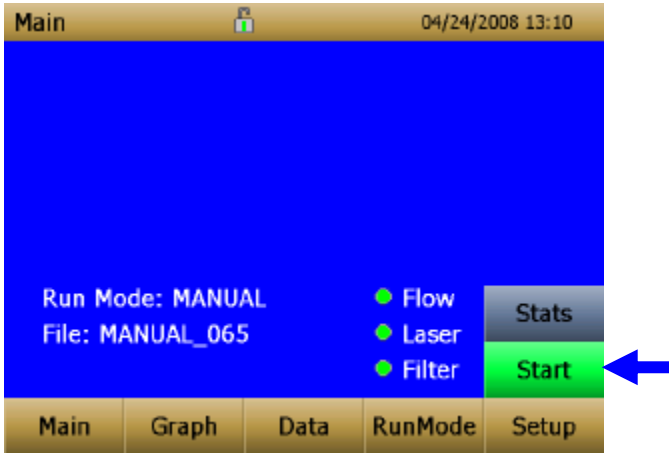

When the instrument is on, but not taking any mass measurements the start button will be green and instruments pump will not be running. To start taking a measurement, press the green **Start** button.

For the Model 8533EP DustTrak monitor with external pump, make sure the external pump is connected to the DustTrak monitor as described in Chapter 2. If the pump is not connected and the green start button is pressed, the DustTrak monitor will identify that the pump is not connected and a warning will be displayed as shown below:

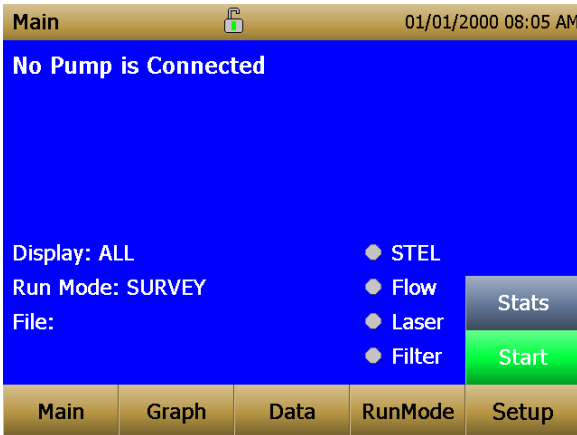

Connect the External Pump Module to the DustTrak monitor and then try again. TSI recommends powering down the DustTrak monitor before connecting the External Pump Module to the DustTrak monitor. Connect the power cable and the flow tubing between the DustTrak monitor and the External pump module, as applicable.

While taking a measurement the screen will display the current measured mass concentration. The various regions of the screen are shown below.

### Screen Regions

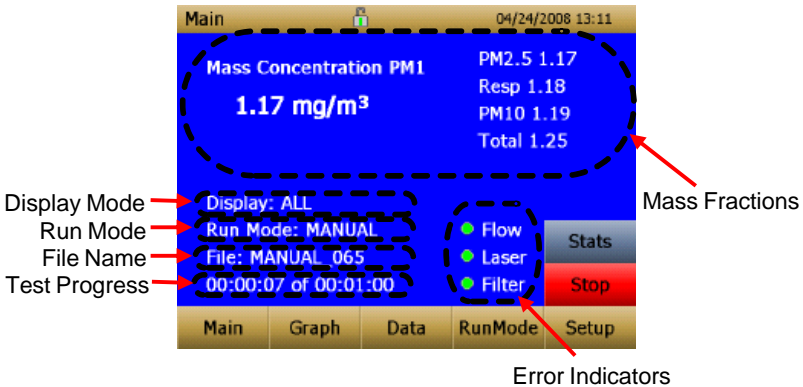

<b>Mass Fractions Region (live keys)</b>	Shows the size segregated mass measurements. The highlighted channel displayed in larger font on the left can be changed by touching on the screen the “measurement of most interest” on the right-hand side of the screen.
<b>Display Mode Region (live key)</b>	The size segregated mass fractions displayed in this area can be selected by touching in the “Display” mode region. The modes that can be selected with this live key are: <b>All:</b> PM <sub>1</sub> , PM <sub>2.5</sub> , Resp, PM <sub>10</sub> and Total <b>IAQ-ENV:</b> PM <sub>1</sub> , PM <sub>2.5</sub> PM <sub>10</sub> and Total <b>IH:</b> Resp, PM <sub>10</sub> and Total
<b>Run Mode Region</b>	Shows the run mode selected from the RunMode screen.
<b>File Name Region</b>	Displays the file name to which the data is currently being saved.
<b>Test Progress Region</b>	Shows the time-based progress of the test.

<b>Error Indicator Region</b>	<p>Shows the current stats of the instrument</p> <p>Flow: Status of the flow control</p> <p>Laser: Status of the Laser</p> <p>Filter: Status of the Filter</p> <p>See <a href="#">Chapter 5. "Troubleshooting."</a> to resolve any of these error conditions.</p>
-------------------------------	---

## Stats

The Stats button shows the statistics of the highlighted channel. To use the stats feature, first select the channel of interest so it is highlighted in large font on the left of the screen.

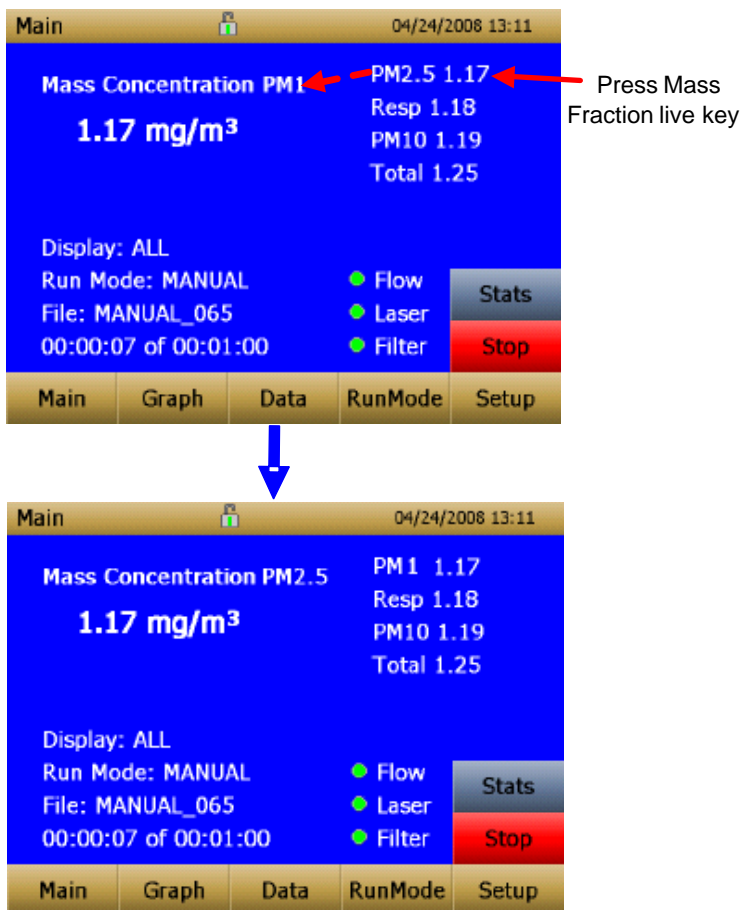

Next, press the Stats button to show the statistics for the highlighted size channel.

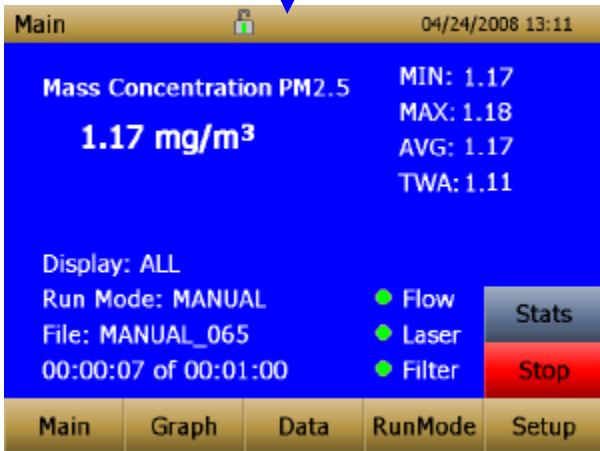
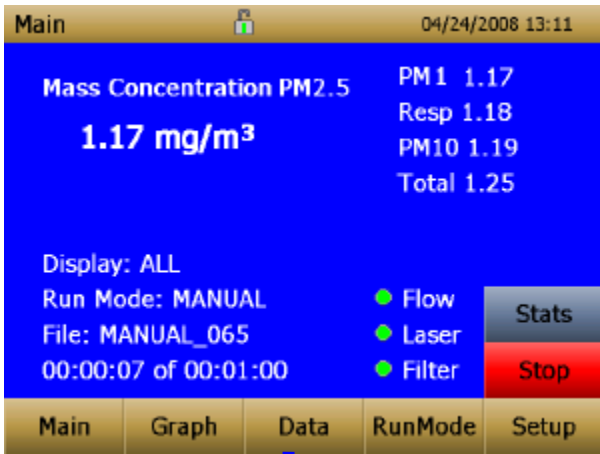



## Graphing

During sampling, pressing the **Graph** button displays current readings in graphical form.

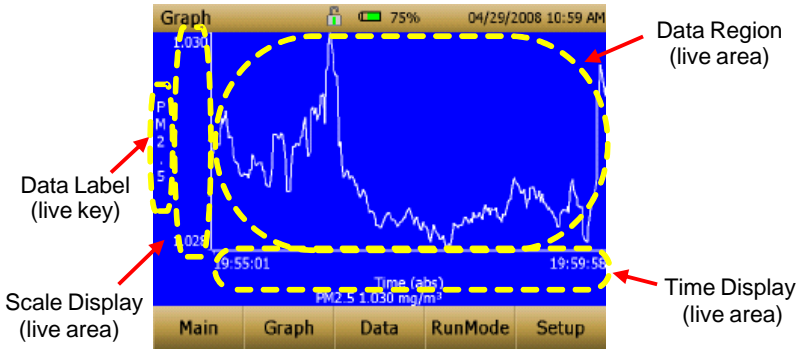
- During Survey Mode, five (5) minutes of running real-time data is displayed graphically.
- During Logging Mode, the entire log test time is displayed on the graph.

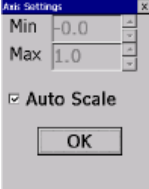

<p><b>Time Display</b></p>	<p>Pressing the <b>Time</b> x-axis label on the graph screen switches between <b>Time (s)</b>, <b>Time (abs)</b>, and <b>Time (rel)</b>.</p> <p><b>Time (s):</b> Elapsed time from first logged point (log interval) to the last logged point (test length).</p> <p><b>Time (rel):</b> Relative time from zero to last logged point (test length – log interval).</p> <p><b>Time (abs):</b> Absolute time from first logged point (test start + log interval) to last logged point (test stop).</p>
<p><b>Scale Display</b></p>	<p>Pressing in the Scale Display area will bring up a dialog that will allow changing between auto scaling and user scaling of the Y-axis.</p> 

<b>Data Label</b>	Pressing the data label will toggle between PM <sub>1</sub> , PM <sub>2.5</sub> , Resp, PM <sub>10</sub> and Total size segregated mass fractions.
<b>Data Region</b>	<p>Pressing the data region will bring up a dialog to show TWA or Average lines.</p>  <p><b>TWA:</b> Will show a secondary line on the graph showing the time weighted average of the data. This line will not show if test time is less then 15 minutes.</p> <p><b>Average:</b> Show a secondary line on the graph of the running average of the data.</p>

In Graphing Mode, pressing **Main** returns the instrument to the Main Screen display.

# Viewing Data

The **Data** button opens a list of data files for viewing.





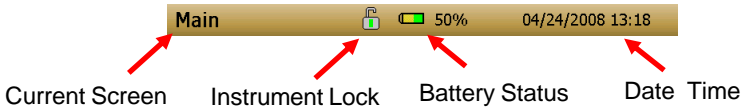

<b>Select File</b>	Press the arrows on the right side of the screen to scroll up or down to the data file to be viewed.
<b>Data Statistics</b>	<p>Statistics on the selected file</p> <ul style="list-style-type: none"> <li>○ File Name</li> <li>○ Size Channel</li> <li>○ Sample Average</li> <li>○ Sample TWA</li> <li>○ Sample Maximum Reading</li> <li>○ Sample Minimum Reading</li> <li>○ Number of Data Points in the File</li> </ul>
<b>Channel Button</b>	Toggles between the mass fraction channels PM <sub>1</sub> , PM <sub>2.5</sub> , Resp, PM <sub>10</sub> and Total.
<b>Save All Button</b>	Downloads data to a USB thumb drive. The USB thumb drive must be attached to the USB host port. Data is saved as a .csv file that can be viewed in Microsoft <sup>®</sup> Excel <sup>®</sup> spreadsheet software.
<b>Delete Button</b>	Deletes the currently highlighted file.
<b>Delete All Button</b>	Deletes all the files stored on the instrument.
<b>Graph Button</b>	Data can also be viewed in graphical form by pressing the <b>Graph</b> button while the data file is highlighted.

# Title Bar

The Title Bar shows common instrument information.



<b>Current Screen</b>	Title of the current screen that is being displayed.
<b>Instrument Lock</b>	<p>Icon shows if the instrument touchscreen is in a unlocked or locked condition.</p> <p>Unlocked: </p> <p>Locked: </p> <p>To lock the touchscreen controls, touch the “lock” icon, immediately followed by three (3) quick touches on the current screen (<b>Main</b>) word along the top tool bar.</p> <p>Repeat the process to unlock the screen.</p>
<b>Battery Status</b>	<p>Show the current % life of the battery and show if the battery is currently being charged:</p> <p>Charging:  (unfilled portion of the icon is filled yellow as well as animated to indicate that the charging is in progress)</p> <p>Not Charging:  (unfilled portion of the icon transparent)</p>
<b>Date and Time</b>	Indicates the instruments current date and time.
<b>Alarm</b>	If the instrument is in a alarm status a alarm icon  will appear in the title bar.



# Chapter 4

## Maintenance

The DustTrak DRX aerosol monitor can be maintained in the field using the instructions below. Additionally, TSI recommends that you return your DustTrak DRX monitor to the factory for annual calibration. For a reasonable fee, we will quickly clean and calibrate the unit and return it to you in “as new” working condition, along with a Certificate of Calibration. This “annual checkup” helps ensure that the DustTrak DRX monitor is always in good operating condition.



### WARNING

There are no user-serviceable parts inside this instrument. The instrument should only be opened by TSI or a TSI approved service technician

## Maintenance Schedule

The DustTrak DRX Aerosol Monitor requires maintenance on a regular basis. Table 4–1 lists the factory recommended maintenance schedule.

Some maintenance items are required each time the DustTrak monitor is used or on an annual basis. Other items are scheduled according to how much aerosol is drawn through the instrument. For example, TSI recommends cleaning the inlet sample tube after 350 hours of sampling a  $1 \text{ mg/m}^3$  concentration of aerosol. This recommendation should be pro-rated according to how the instrument is used. 350 hours at  $1 \text{ mg/m}^3$  is the same amount of aerosol as 700 hours at  $0.5 \text{ mg/m}^3$  or 175 hours at  $2 \text{ mg/m}^3$ , etc.

**Table 4–1. Recommended Maintenance Schedule**

Item	Frequency
Perform zero check	Before each use.
Clean inlet	350 hr. at $1 \text{ mg/m}^3$ *
Clean $2.5 \text{ }\mu\text{m}$ calibration impactor	Before every use.
Replace internal filters	350 hr. at $1 \text{ mg/m}^3$ * or when indicated by the main screen filter error indicator.
Return to factory for cleaning and calibration (For 8533EP, TSI recommends that both the DustTrak monitor and the External Pump Module be returned to TSI)	Annually
Replace the internal HEPA filters in the External Pump module	Annually

\*Pro-rated, see discussion above.

The DustTrak monitor keeps track of the accumulated amount of aerosol drawn through it since its last cleaning. When the internal filter replacement is due, the filter error indicator will turn from green to red.

TSI recommends you perform a zero check prior to each use for the DustTrak monitor and certainly before running any extended tests, and after the instrument experiences a significant environmental change. Examples of significant environmental changes would be ambient temperature changes that exceed 15°F (8°C) or moving from locations with high aerosol concentrations to low concentrations.

## Zeroing Instrument

1. Attach the zero filter to the inlet of the instrument.



**Figure 4-1: Attach Zero Filter to Inlet**

2. Follow zero calibration instructions detailed in the operations section of this manual,

## Cleaning the Inlet

The inlet should be cleaned based on the schedule in Table 4–1.

1. Turn the DustTrak monitor off.
2. Unscrew the inlet nozzle from the instrument (Figure 4-2).

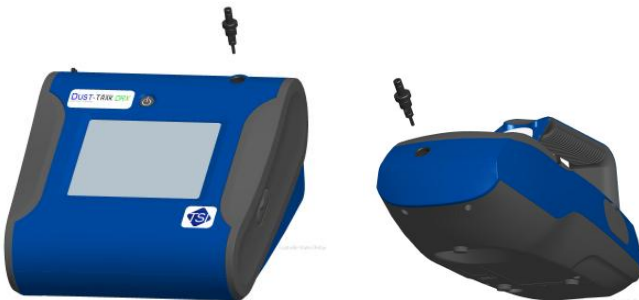

**Figure 4-2: Unscrew Inlet Nozzle**

3. Clean the inlet port. Use a cotton swab to clean the outside of the inlet port. The swabs can be dampened with water or a light solvent (e.g., isopropanol). Clean the inside of the sample tube by using a small brush, along with a light solvent. Dry the tube by blowing it out with compressed air, or let it air-dry thoroughly.

**Note**

**Be *careful* not to blow particles into the DustTrak monitor inlet port.**



**Figure 4-3: Do NOT Blow into Instrument**

4. Screw (hand-tighten) inlet back into instrument.

## Cleaning 2.5 $\mu\text{m}$ Calibration Impactor

The calibration impactor should be cleaned prior to every use, using it to perform a Standard Calibration (size correction) on the instrument, as described in the [Operations](#) section.

1. Unscrew Impactor. Check O-ring on the impactor base.
2. Clean outside and inside of Impactor and the impactor plate using a clean brush and a light solvent. Dry impactor parts by blowing it out with compressed air, or let it air-dry thoroughly.
3. Apply 2 drops of oil (included) to the impactor plate. Do **not** over-fill impactor plate.

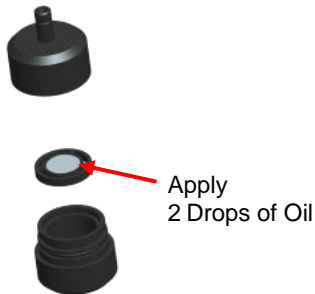

**Figure 4-4: Apply 2 Drops of Oil to Impactor Plate**

4. Screw (hand-tighten) impactor back together.

## Replacing the Internal Filters

Replace the internal filters based on the schedule in Table 4–1 or when the filter indicator on the main screen changes to red.

1. Turn the instrument off.
2. Remove old filters from the instrument.

### Handheld Model

- a. Use the enclosed filter removal tool (PN 801668) tool to unscrew the two filter caps located on the bottom of the instrument.
- b. Pull the old filters out of the two filter wells. If filter wells are visibly dirty, blow out with compressed air.



**Figure 4-5: Pull Filters Out of Two Filter Wells (Handheld Model)**

- c. Put two (2) new filters into the filter wells and screw filter caps back into place.

Note
Replacement filters were shipped with the new instrument. Order additional filters from TSI under PN 801666.

### Desktop Model

- a. Open filter access door on the back of the instrument.
- b. Use the enclosed filter removal tool (PN 801668) to unscrew the filter cap.

- c. Pull out single cylindrical filter from filter well. If filter well is visibly dirty, blow out with compressed air.



**Figure 4-6: Pull out Single Cylindrical Filter from Filter Well (Desktop Model)**

- d. Put a new filter (P/N 801673) back into filter well and screw filter cap back into place.
- e. Open blue retention clip by pinching ends inward and pushing down.



**Figure 4-7: Open Blue Retention Clip**

- f. Remove 37-mm filter cassette by pulling downward and outward.



**Figure 4-8: Remove 37-mm Filter Cassette**

- g. Open filter cassette using enclosed tool PN 7001303.

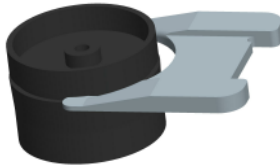

**Figure 4-9: Open Filter using Enclosed Tool**

- h. Remove screen mesh from filter cassette and blow out using compressed air. Blow in reverse direction to remove captured particulate.
- i. Replace mesh in filter cassette and press halves together. Ensure filter has been fully closed. The filter tool PN 7001303 can be used to ensure the filter is fully closed.



**Figure 4-20: Replace Mesh in Filter Holder**

- j. Place filter cassette back into position and close blue retaining clip. Make sure retaining clip snaps back into place.

### Notes

Replacement filters (HEPA and 3-mm Filter Cassette with mesh filter) were shipped with the new instrument. Order additional filters from TSI under PN 801673.

TSI **does not** supply any filter media for the filter cassette. Any commercially available 37-mm filter media may be used with the DustTrak II or DRX desktop instruments to collect gravimetric reference samples.

3. **It is important to reset the instruments filter counter after replacing filters. Resetting the counter will clear the filter error condition shown on the main screen.** Reset the counters by the following:
  - a. Turn on the instrument.
  - b. Press the **Setup** button to go into the setup screen.
  - c. Touch the **Cum Filter Conc:** (live key) to reset the aerosol mass.

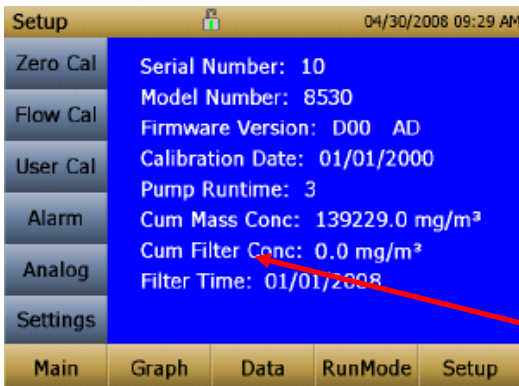

Touch

- d. *Replace user serviceable filters?* Dialog will appear. Press **OK**.
- e. *Reset filter concentration?* Dialog will appear. Press **Yes** to reset the cumulative filter concentration to zero.
- f. The Setup screen will not show zero for the **Cum Filter Concentration and** the current date for the **Filter Time**.

## Replacing the Filters in the External Pump Module

The external pump module provided with Model 8533EP is designed to run continuously for about a year (8760 hours). There are two HEPA filters that protect the pump from contamination—one on the suction side of the pump and the other on the discharge side of the pump. The discharge side of the pump collects particles shedding from the vanes of the pump and will turn black over time. The HEPA filters will have to be replaced once a year.

To access the filters open the top cover of the pump module. The two HEPA filters are identified in the figure below. The two filters can be replaced by disconnecting the soft tubing between the filters, pump, and the casing connectors.

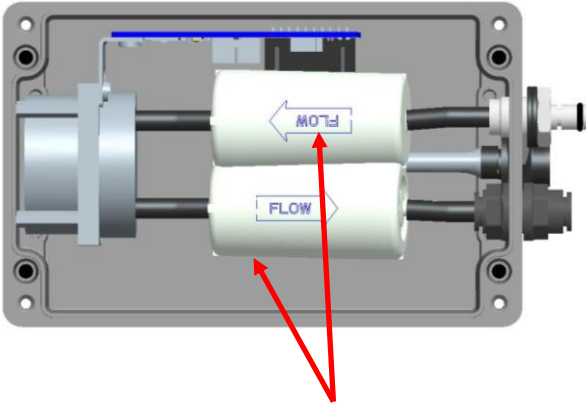

User Replaceable HEPA Filters



### Caution

When replacing the HEPA filters, make sure they are oriented in the correction direction as shown in the picture above.

### Storage Precautions

When storing the DustTrak monitor for more than 30 days, you should charge and remove the batteries. This prevents damage due to battery leakage.

This instrument must be stored in a location where the temperature remains between  $-20$  and  $60^{\circ}\text{C}$  ( $-4$  and  $140^{\circ}\text{F}$ ).



# Chapter 5

## Troubleshooting

The table below lists the symptoms, possible causes, and recommended solutions for common problems encountered with the DustTrak DRX monitor.

Symptom	Possible Cause	Corrective Action
Erratic zero reading	Leak	Check connections for leaks  Replace zero filter
	Dirty inlet port and/or sample tube	Clean inlet port. Clean or replace tubing
	Internal filter(s) not installed properly (leaking)	Inspect internal filter wells to make certain the filters and o-rings are seated properly. Replace internal filters if necessary
DustTrak reading negative concentrations	Zero Drift	Perform Zero Cal
	Zero Cal was performed without the Zero Filter in-line	Perform Zero Cal again and make sure the Zero Filter is attached to the DustTrak inlet
Error completing Zero Cal	Too much light scatter in the optics chamber due to dust deposits	Clean the inlet nozzle. Attach the zero filter and sample for about 2 minutes. During sampling, pulse the flow going into the DustTrak monitor by intermittently plugging the zero filter. Any dust in the optics chamber will break loose during flow pulsations and will be cleared out by the pump
		Perform Zero Cal again. If the Zero Cal still cannot be performed, factory service may be required

Symptom	Possible Cause	Corrective Action
Run Mode Error: The start time has passed	The selected Run Mode program has "Use Start Date" selected, but the start date is prior to the current date	Correct or change the run mode program
Run Mode Error: The selected log mode will exceed the allowed number of samples	The selected Run Mode program is programmed to save more samples than is room in memory	Reduce the number of samples by reducing the test length or increasing the logging interval
Instrument runs slow	Large amount of data in memory	Large data files or many small data files will cause instrument to slow, due to need to read and display large amounts of data
No display	Unit not switched on  Low or dead batteries	Switch unit on  Recharge the batteries or plug in the AC adapter
No touch - screen response	Instrument currently busy  Instrument Touchscreen is locked	The instrument will take time to open large data files and save configuration information. During this time, the instrument will not respond to additional touch-screen touches  If the lock in the title bar is red, unlock the instrument following the instructions in the <a href="#">Chapter 3, Operation: Title Bar</a> section of this manual
Analog output does not work	Cable/connector not correctly installed  Output wired with reverse polarity	Make sure cable connector is fully seated  Make sure analog out (+) and analog ground (-) are wired correctly to data-logger

Symptom	Possible Cause	Corrective Action
Analog output is not in proportion to display	Analog output range in DustTrak monitor may be set incorrectly  Data logger scaling factor may be set incorrectly	Check analog output setting in the Setup->Analog screen. Make sure the channel of interest is selected. Make sure that the correct output (0 to 5V, 4 to 20 mA) is selected  Review the scaling factor set in the Setup-Analog screen
Alarm output does not work  Alarm does not turn on correctly	Alarm function not turned on  Alarm setting incorrect  Alarm output wired with reverse polarity	Turn the alarm function on in the Settings->Alarm screen  Check the alarm settings in the Settings->Alarm screen  Make sure the logging interval and time constant are set as short as possible (30 seconds or lower)  Alarm wires are polarized. Voltage input must be wired to alarm input (+)
Instrument does not store new data	Memory is full  Instrument is in Survey mode	Delete or transfer historic data  The instrument does not store data in survey mode. Can to manual or program log mode

Symptom	Possible Cause	Corrective Action
Flow Error is indicated on front screen	<p>If sampling from a duct, instrument may have problems overcoming pressure differences</p> <p>Flow obstruction</p> <p>Internal pump failing, indicated by inability to adjust flow rate to full range</p> <p>Filter Cassette clogged or has mass loading</p> <p>External pump module (for Model 8533EP only) is not connected to the DustTrak monitor</p>	<p>Attach both the input and the exhaust port into the duct</p> <p>Remove obstruction if still present. Press any key to bypass</p> <p>Factory service may be required</p> <p>Replace the filter cassette. See the <a href="#">maintenance</a> section of the manual</p> <p>Make sure both the External Pump cable and the flow tubing connector are connected to the DustTrak monitor and the External pump module. Lock the External Pump Cable in place by rotating the connector clockwise until you hear it snap in place</p> <p>Make sure the tubing between the DustTrak monitor and the External pump module is not kinked and is free of any sharp bends</p> <p>Make sure the exhaust adapter is connected to the exhaust of the DustTrak monitor</p> <p>Make sure the External Pump module filters are not clogged. If found dirty, replace the two HEPA filters</p>
Laser Error indicated on front screen	<p>Laser background is too high</p> <p>Laser is failing</p>	<p>Remove and clean inlet nozzle. Pay close attention to the tip of the nozzle that is inserted into the instrument to ensure it is clear of any contamination</p> <p>Factory service may be required</p>

Symptom	Possible Cause	Corrective Action
Filter Error indicated on front screen	Filters need to be replaced	<p>Replaced the filters per instructions in the maintenance section of this manual. Make sure to reset the filter mass and date once the filters have been changed</p> <p><b>Note:</b> This is only a warning. The unit will continue to operate normally until the increase in pressure drop across the filter is so high that the pump can no longer maintain the set flow rate</p>
System Error has Occurred!	The processor did not receive the input it expected. This can also happen if the optics chamber is saturated with light, or the External Pump Cable is accidentally disconnected during the middle of sampling	Reboot the instrument. If the error does not go away, factory service is required

*(This page intentionally left blank)*

# Appendix A

## Specifications

Specifications are subject to change without notice.

Sensor Type	90° light scattering
Range	8533 Desktop 0.001 to 150 mg/m <sup>3</sup> 8534 Handheld 0.001 to 150 mg/m <sup>3</sup>
Display	Size Segregated Mass Fractions for PM <sub>1</sub> , PM <sub>2.5</sub> , Respirable, PM <sub>10</sub> and Total. All displayed
Resolution	±0.1% of reading of 0.001 mg/m <sup>3</sup> , whichever is greater
Zero Stability	±0.002 mg/m <sup>3</sup> 24 hours at 10 sec time constant
Particle Size Range	Approximately 0.1 to 15 µm
Flow Rate	3.0 L/min
Flow Accuracy	±5% Internal flow controlled
Temperature Coefficient	+0.001 mg/m <sup>3</sup> per °C
Operational Temp	0 to 50°C
Storage Temp	-20 to 60°C
Operational Humidity	0-95% RH, non-condensing
Time Constant	Adjustable 1 to 60 seconds
Data Logging	<45 days at 1 minute samples
Log Interval	1 second to 1 hour
Physical Size (HWD)	Handheld: 4.9 x 4.75 x 12.45 in. Desktop: 5.3 x 8.5 x 8.8 in. External Pump: 4.0 x 7.5 x 3.5 in.
Weight	Handheld: 2.9 lb, 3.3 lb with battery Desktop: 3.45 lb, 4.45 lb – 1 battery, 5.45 lb – 2 batteries External Pump: 3.0 lb
Communications	8533: USB (Host and Device) and Ethernet. Stored data accessible using thumb drive 8534: USB (Host and Device). Stored data accessible using thumb drive.
Power—DC	Handheld 12 VDC at 2A Desktop 24 VDC at 2.5A

Battery	<p>8533: Up to 2 Removable Li-Ion External and Internal charging Life, 1 battery: &gt;6.5 hours (9 hours typical for a new battery) for both internal and external pump Desktop DustTrak monitors Life, 2 battery: &gt;13 hours</p> <p>8534: 1 Removable Li-Ion External and Internal charging Life: 6 hours typical</p>
Analog out	<p>8533 User selectable output 0 to 5 V or 2 to 20 mA User selectable scaling</p>
Alarm Out	<p>8533: STEL Relay or sound buzzer Relay     No latching MOSFET     User selectable set point     5% deadband     Connector 4-pin, Mini-DIN connectors</p> <p>8534: Sound buzzer</p>
Screen	<p>8533: 5.7" color touchscreen 8534: 3.5" color touchscreen</p>
Gravimetric Sampling	<p>8533: Removable 37 mm Cartridge</p>
EMI/RF Immunity:	<p>Complies with Emissions Directive Standard: EN50081-1:1992 Complies with Immunity Directive Standard: EN50082-1:1992*</p>

\*ESD Shock may require instrument reboot



# Appendix B

## DRX Advanced Calibration

---

The advanced calibration method is employed to yield high size segregated mass concentration accuracy for PM<sub>1.0</sub>, PM<sub>2.5</sub>, Respirable and PM<sub>10</sub> size fractions. It involves two gravimetric measurements to obtain PCF and SCF. The two gravimetric measurements can be done in sequence or in parallel, depending on the gravimetric sampling device availability.

### Option 1: Serial Gravimetric Calibration

When you have only one set of gravimetric sampling devices, the DustTrak DRX advanced calibration can be performed in two serial steps. The experimental setup is in Figure B-1a. The calibration steps are outlined below:

#### Step 1: PCF Calibration

- Install a PM<sub>2.5</sub> impactor at the inlet of the external gravimetric filter.
- Co-locate and run the gravimetric sample and DustTrak DRX monitor simultaneously to collect enough mass on the gravimetric filter.
- Calculate the PM<sub>2.5</sub> mass concentration (PM<sub>2.5\_Grav</sub>) from the gravimetric filter based on the net mass collected on the filter, sampling time, flow rate, and total liters of air sampled.
- Read the DustTrak DRX monitor average PM<sub>2.5</sub> mass concentration (PM<sub>2.5\_DRX</sub>) from the screen or through TrakPro Data Analysis Software.
- Calculate the new PCF

$$PCF_{New} = \frac{PM_{2.5\_Grav}}{PM_{2.5\_DRX}} \times PCF_{Old}$$

- Update the new PCF in user calibration settings.

#### Step 2: SCF Calibration

- Install a PM<sub>10</sub> impactor at the inlet of the external gravimetric filter.
- Co-locate and run the gravimetric sample and DustTrak DRX monitor simultaneously to collect enough mass on the gravimetric filter.
- Calculate the PM<sub>10</sub> mass concentration (PM<sub>10\_Grav</sub>) from the gravimetric filter based on the net mass collected on the filter, sampling time, flow rate, and total liters of air sampled.
- Read the DustTrak DRX monitor average PM<sub>2.5</sub> (PM<sub>2.5\_DRX</sub>) and PM<sub>10</sub> (PM<sub>10\_DRX</sub>) mass concentration from the screen or through TrakPro Data Analysis Software.
- Calculate the new SCF

$$SCF_{New} = \left( \frac{PM_{10\_Grav} - PM_{2.5\_DRX}}{PM_{10\_DRX} - PM_{2.5\_DRX}} \right)^{\frac{1}{3}} \times SCF_{Old}$$

- Update the new SCF in user calibration settings.

## Option 2: Parallel Gravimetric Calibration

When you have two sets of gravimetric sampling devices, the DustTrak DRX monitor advanced calibration can be performed in the parallel configuration as shown in Figure B-1b. The calibration steps are outlined below:

1. Install a  $PM_{2.5}$  and a  $PM_{10}$  impactor at the inlet of the two external gravimetric filters, respectively.
2. Co-locate and run the gravimetric samples and DustTrak DRX monitor simultaneously to collect enough mass on the gravimetric filters.
3. Calculate the  $PM_{2.5}$  ( $PM_{2.5\_Grav}$ ) and  $PM_{10}$  ( $PM_{10\_Grav}$ ) mass concentrations from the gravimetric filters based on the net mass collected on the filter, sampling time, flow rate, and total liters of air sampled.
4. Read the DustTrak DRX monitor average  $PM_{2.5}$  and  $PM_{10}$  mass concentration ( $PM_{2.5\_DRX}$  and  $PM_{10\_DRX}$ ) from the DRX screen or through TrakPro Data Analysis Software.

5. Calculate the new PCF

$$PCF_{New} = \frac{PM_{2.5\_Grav}}{PM_{2.5\_DRX}} \times PCF_{Old},$$

and the new SCF

$$SCF_{New} = \left( \frac{PM_{10\_Grav} - PM_{2.5\_Grav}}{PM_{10\_DRX} - PM_{2.5\_DRX}} \right)^{\frac{1}{3}} \times SCF_{Old}.$$

6. Update the new SCF and PCF in the user calibration settings.

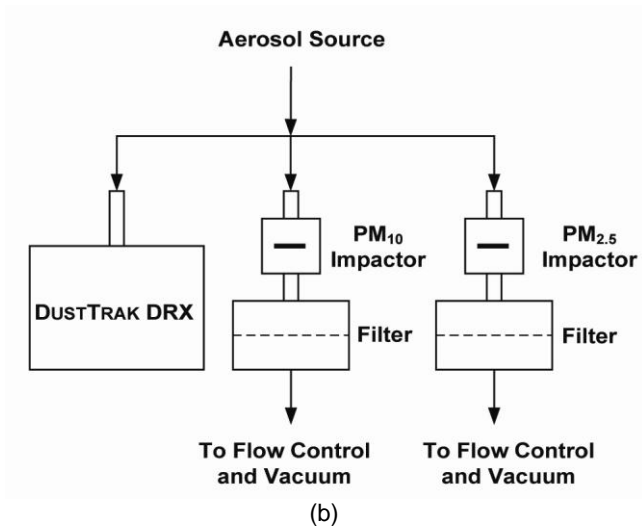
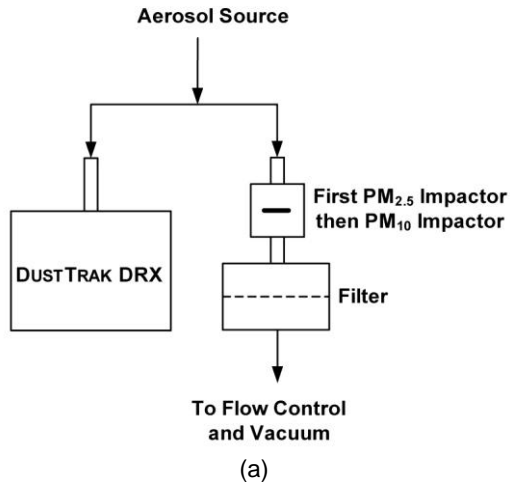

**Figure B-1: Experimental Setup for  
(a) Serial and (b) Parallel Gravimetric Calibration**

*(This page intentionally left blank)*

# Appendix C

## Zero Module

---

The Zero Module (PN 801690) allows for automatic re-zeroing of the DustTrak Instrument during long sampling runs. The Zero Module works only with the 8533 desktop model.

Attach the AutoZero module to the main instrument in two steps.

1. Place the Zero module over the instrument's inlet and press down. The Zero module has an O-ring seal that will engage with the instrument's inlet.

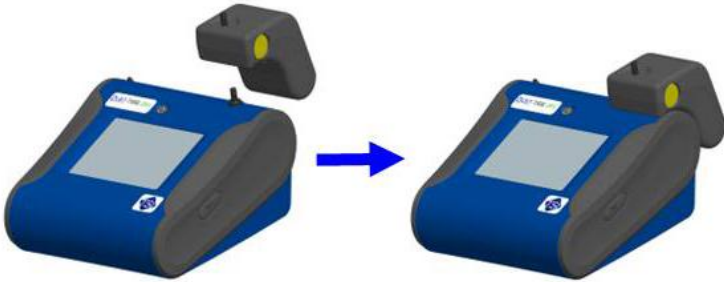

**Figure C-1: Place Zero Module Over Inlet and Press Down**

2. Attach the cable from the Zero module to the Zero module connector located on the back of the instrument.



**Figure C-2: Zero Module Connector**

The Zero Module can only be used in a program log mode. The Zero module function is controlled through these two program mode options:

- |                           |  |
|---------------------------|--|
| <b>Auto Zero Interval</b> | Interval between re-zeroing the instrument using the Auto-Zero accessory.              |
| <b>Use Auto Zero</b>      | Select <b>Yes</b> to use the Zero Module. Select <b>No</b> to not use the Zero Module. |

Important points on Zero Module operation:

- The Zero module will take 1 minute to take a zero reading. The first 45 seconds of that period is used to clear the chamber of particles. Readings from last 15 second of the period, when the chamber is cleared of particles, will be averaged to determine the Zero offset.
- The log interval, when the Zero module is activated, must be 2 minutes or greater. Data will not be recorded to the log file when the Zero module is activated.

# Index

---

## 4

4-pin miniDIN connector, 14

## A

AC adapter, 12  
advanced calibration, 63  
advisory labels, vi  
aerosol monitor  
    maintenance, 47  
    specifications, 61  
    troubleshooting, 55  
alarm, 29, 46  
    audible, 31  
    logging interval, 29, 30  
    relay1, 30  
    STEL 1, 31  
    survey mode, 30  
    visible, 31  
    wiring, 15  
alarm functioning, 29  
alarm1 setpoint, 30  
alarm2 enable, 31  
alarm2 setpoint, 31  
analog, 33  
    lower limit, 33  
    out, 33  
    output setting, 33  
    size fraction, 33  
    upper limit, 33  
analog output  
    wiring, 14  
analog/alarm cable, 2  
analog/alarm output  
    connecting, 14  
audible, 31  
auto start on power up, 36  
auto zero interval, 68

## B

battery  
    charging, 12  
battery charger, 4  
battery installation, 9  
    desktop unit, 9  
    handheld unit, 10

battery status  
    charging, 46  
    not charging, 46

## C

calibration certificate, 2  
calibration date, 20  
calibration factor  
    for specific aerosol, 27  
calibration impactor  
    cleaning, 49  
calibration impactor kit, 3  
caution symbols, vii  
channel button, 45  
charging battery, 12  
Class I, v  
clean inlet, 47  
cleaning  
    inlet conditioner, 48  
communication errors, 18  
conductive tubing, 3  
connect exhaust adapter to  
    exhaust of DustTrak (8533EP),  
    11  
connect power connector to  
    DustTrak (8533EP), 11  
connect pump end of quick  
    connect to pump module  
    (8533EP), 10  
connecting  
    analog/alarm output, 14  
connecting computer, 13  
current screen, 46  
custom cal, 25

## D

data, 45  
    channel button, 45  
    delete, 45  
    save all button, 45  
    select file, 45  
    statistics, 45  
delete, 45  
determining calibration factor for  
    specific aerosol, 27  
display mode region, 40  
DustTrak 8530EP, 17

DustTrak 8533EP, 17

## E

- error indicator region, 41
- error messages, 55
- Ethernet port IP parameters, 34
- exhaust adapter, 5
- external pump kit, 5
- external pump module, 7, 17, 18, 19
  - connecting, 40

## F

- file name region, 40
- filter cassette, 52, 53
  - troubleshooting, 58
- filter error, 59
- filter opening tool, 3
- filter removal tool, 3
- filter time, 20
- firmware version, 20
- flow cal, 22
- flow error, 58

## G–H

- graph, 43
  - button, 45
  - data label, 44
  - data region, 44
  - scale display, 43
  - time display, 43
- gravimetric sample, 26

## I–J–K

- impactor oil, 4
- inlet cap, 5, 12
- inlet conditioner
  - cleaning, 48
- installing batteries, 9
- instrument lock, 46
- instrument setup, 13
- internal filter
  - replacing, 47
- internal filter, 3
  - replacing, 50
- internal filter element, 3
- internal gravimetric filter, 28

## L

- laser error, 58
- laser radiation label, vi
- log interval, 37, 38
- log mode, 35, 38
  - auto zero interval, 38
  - log interval, 38
  - log name, 38
  - number of tests, 38
  - start date, 38
  - start time, 38
  - test length, 38
  - time between tests, 38
  - time constant, 38
  - use start date, 38
  - use start time, 38
- log modes, 35
- log name, 38

## M

- maintenance, 47
  - schedule, 47
- manual log, 35
- manual mode, 37
  - log interval, 37
  - test length, 37
  - time constant, 37
- mass concentration measurements, 39
- mass fractions region, 40
- model number, 20

## N–O

- name, 24
- newcal, 28
- number of tests, 38

## P–Q

- packing list, 1
- parallel gravimetric calibration, 64
- parts identification, 6, 7, 8
- PCF calibration, 63
- photometric, 24, 29
- power supply, 4
- pump run time, 20



## R

- rechargeable battery, 2
- relay1, 30
- replacing filters in the external pump module (8533EP), 53
- replacing internal filter, 50
- reusing and recycling, vii
- run mode region, 40
- runmode, 35

## S

- safety information, v
- save all button, 45
- SCF calibration, 63
- screen regions, 40
- screwdriver, 4
- select file, 45
- serial gravimetric calibration, 63
- serial number, 20
- serial number label, vi
- service policy, ii
- setting up, 9
  - instrument, 13
- settings, 33
  - date time, 33
  - display, 34
  - IP, 34
  - touch cal, 34
- setup menu, 20
  - calibration date, 20
  - cum filter conc, 20
  - cum mass conc, 20
  - filter time, 20
  - firmware version, 20
  - model number, 20
  - pump run time, 20
  - serial number, 20
- size corr, 24
- size fraction, 33
- software
  - installation, 13
- spanner driver, 3
- specifications, 61
- standard calibration method-photometric calibration factor, 27
- standard calibration method-size correction factor, 24
- start date, 38
- start time, 38

- start up, 17
- START UP screen, 17
- stats, 41
- STEL, 32
  - alarm repeat, 32
  - data, 32
  - indicator, 32
- STEL 1, 31
- storage precautions, 54
- stylus, 4
- supplying power, 9
- survey mode, 35, 36
  - time constant, 36
- system error, 59

## T

- test length, 37
- test progress region, 40
- time between tests, 38
- time constant, 36, 37, 38
- title bar, 46
  - alarm, 46
  - battery status, 46
  - current screen, 46
  - date and time, 46
  - instrument lock, 46
- TrakPro™ software
  - installation, 13
- troubleshooting, 55

## U

- unpacking, 1
- USB cable, 2
- USB port
  - connector, 13
- USB port IP address, 34
- use auto zero, 68
- use start date, 38
- use start time, 38
- user cal, 23, 24
  - name, 24
  - photometric, 24
  - size corr, 24
- user replaceable HEPA filters (8533EP), 54

## V

- visible, 31

## **W-X-Y**

warning, v  
warning symbols, vii  
warranty, i  
wiring alarm, 15  
wiring analog output, 14

## **Z**

zero cal, 21  
    error, 55  
zero check, 47  
zero filter, 2, 48  
zero module, 67  
zeroing instrument, 48



UNDERSTANDING, ACCELERATED

**TSI Incorporated** – Visit our website [www.tsi.com](http://www.tsi.com) for more information.

**USA** Tel: +1 800 874 2811

**UK** Tel: +44 149 4 459200

**France** Tel: +33 4 91 11 87 64

**Germany** Tel: +49 241 523030

**India** Tel: +91 80 67877200

**China** Tel: +86 10 8251 6588

**Singapore** Tel: +65 6595 6388